

**Honeywell**

# **LYNX Touch Series Security Systems**

## ***Installation and Setup Guide***

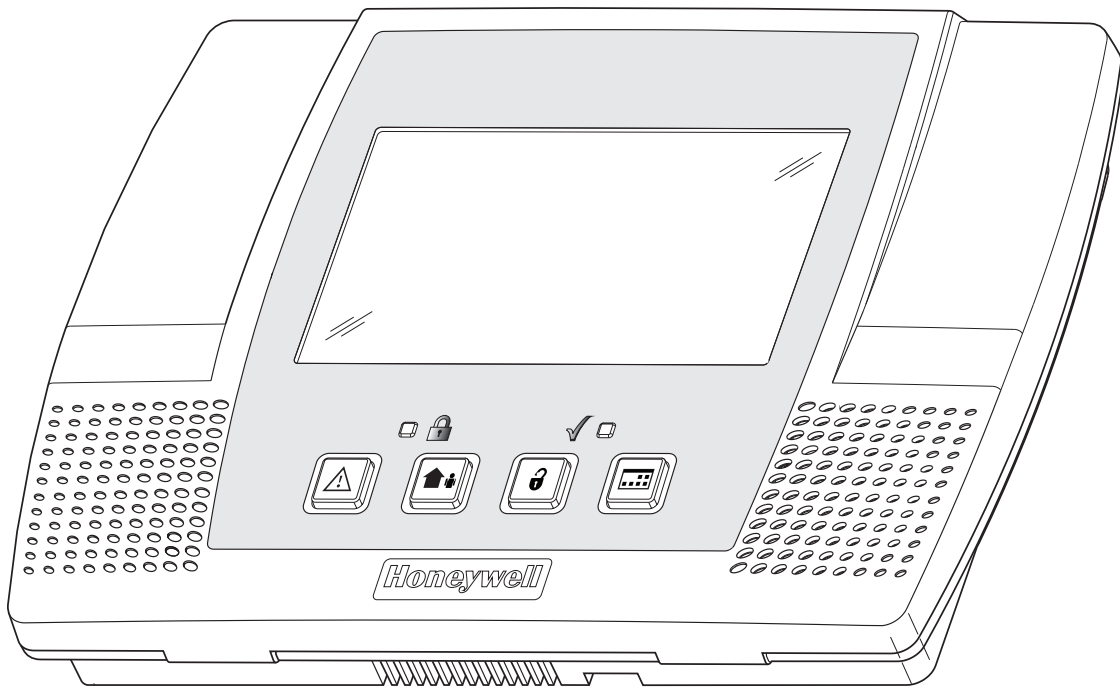

## RECOMMENDATIONS FOR PROPER PROTECTION

The Following Recommendations for the Location of Fire and Burglary Detection Devices Help Provide Proper Coverage for the Protected Premises.

### Recommendations for Smoke and Heat Detectors

With regard to the number and placement of smoke/heat detectors, we subscribe to the recommendations contained in the National Fire Protection Association's (NFPA) Standard #72 noted below.

- Early warning fire detection is best achieved by the installation of fire detection equipment in all rooms and areas of the household as follows: For minimum protection a smoke detector should be installed outside of each separate sleeping area, and on each additional floor of a multi-floor family living unit, including basements. The installation of smoke detectors in kitchens, attics (finished or unfinished), or in garages is not normally recommended.
- For additional protection the NFPA recommends that you install heat or smoke detectors in the living room, dining room, bedroom(s), kitchen, hallway(s), attic, furnace room, utility and storage rooms, basements and attached garages.

In addition, we recommend the following:

- Install a smoke detector inside every bedroom where a smoker sleeps.
- Install a smoke detector inside every bedroom where someone sleeps with the door partly or completely closed. Smoke could be blocked by the closed door. Also, an alarm in the hallway outside may not wake up the sleeper if the door is closed.
- Install a smoke detector inside bedrooms where electrical appliances (such as portable heaters, air conditioners or humidifiers) are used.
- Install a smoke detector at both ends of a hallway if the hallway is more than 40 feet (12 meters) long.
- Install smoke detectors in any room where an alarm control is located, or in any room where alarm control connections to an AC source or phone lines are made. If detectors are not so located, a fire within the room could prevent the control from reporting a fire or an intrusion.

**THIS CONTROL COMPLIES WITH NFPA REQUIREMENTS FOR TEMPORAL PULSE SOUNDING OF FIRE NOTIFICATION APPLIANCES.**

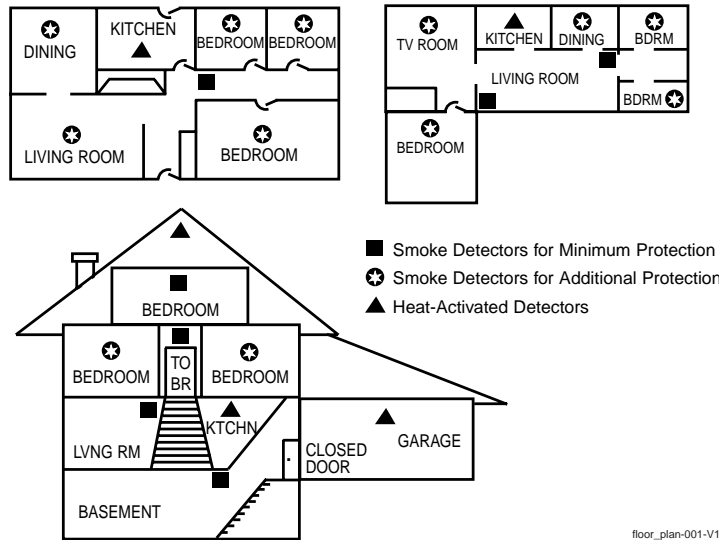

### Recommendations For Proper Intrusion Protection

- For proper intrusion coverage, sensors should be located at every possible point of entry to a home or premises. This would include any skylights that may be present, and the upper windows in a multi-level building.
- In addition, we recommend that radio backup be used in a security system. This will ensure that alarm signals can be sent to the alarm monitoring station in the event that the telephone lines are out of order (alarm signals are normally sent over the phone lines, if connected to an alarm monitoring station).

## **Table of Contents**

<b>System Features</b> .....	5
Features .....	5
<b>Mounting the Control</b> .....	6
Wall Mounting .....	6
Desktop Mounting .....	6
Wiring Overview .....	6
<b>Wiring Connections</b> .....	7
Installing the L5000-RJ-31X in the LYNX Touch Control .....	8
<b>AC Power and Backup Battery</b> .....	9
<b>Installing/Configuring Communications &amp; Home Automation Modules</b> .....	10
General .....	10
Connecting and Configuring Communications Modules .....	10
Installing the GSMVLP5-4G/GSMVLP5CN4G .....	10
Installing the ILP5 .....	11
Installing the L5100-WiFi Module .....	12
Installing the L5100-ZWAVE Module .....	12
<b>Installing Wireless Zones</b> .....	13
General Information .....	13
Zones .....	13
Range .....	13
Transmitters .....	13
House Identification .....	13
Transmitter Supervision .....	13
Transmitter Input Types .....	13
Transmitter Battery Life .....	13
RF Sniffer Mode Test .....	14
Go/No Go Test .....	14
5800 Series Transmitter Loop Numbers .....	15
<b>Mechanics of Programming</b> .....	16
Navigating Menus .....	16
Touch-screen Display .....	16
Navigation Keys .....	16
Dashboard Screen .....	16
Security Screen Menus .....	17
Installer Tools Menu .....	17
User Tools Menu .....	17
General Programming Information .....	18
Programming .....	18
Enter Installer Programming Mode .....	18
Loading Factory Defaults .....	18
Select a Default Configuration .....	18
Exiting programming Mode .....	19
<b>Zone Response Type Definitions</b> .....	20
General Information .....	20
<b>Programming the Control</b> .....	22
Enter Installer Programming Mode without using Installer Code .....	22
Change Installer Code .....	22
Select a Language .....	22
System Type .....	23
Program Date and Time .....	25
Program the Communications Module .....	26
Program the Z-Wave Module .....	28
Program Zones .....	29
Program Keys .....	31
Program Reporter .....	33
Sounder .....	39
System Settings .....	40
Communications Diagnostics .....	43
Communications Status .....	43

**Table of Contents (Continued)**

Ethernet Information .....	43
GSM Information.....	43
Communications ID Numbers.....	44
Test Communications .....	44
Setup Communications .....	44
Registering the LYNX Touch .....	44
Register through AlarmNet Direct Website .....	45
Register by Phone .....	45
Register through LYNX Touch Diagnostics .....	45
Register Device with PIN .....	46
Update Server .....	47
Enroll the L5100-WiFi Module .....	48
Enroll Using Scan Access Points.....	48
Manually Configure Access Points .....	48
WiFi Protected Set-up (WPS).....	49
Factory Defaults .....	49
<b>Remote Programming/Control (Downloading)</b> .....	50
General Information .....	50
Remote Programming Information .....	50
Remote Programming Advisory Notes.....	51
<b>System Operation</b> .....	52
Key/Touchscreen Operation .....	52
Panic Key/Icons.....	52
Security Codes.....	52
Installer Code.....	52
Master Code .....	52
Enter/Change the Master Code by Installer .....	52
Secondary User Codes .....	53
Reset Master User Code .....	53
Security Code Notes.....	53
“Follow Me” System Announcement Feature .....	54
“Follow Me” Reminder Feature.....	55
Remote Phone Control Feature.....	55
System Displays.....	56
Zone Status Displays .....	56
Audio alarm Verification (Two-Way Voice Feature) .....	57
Activation .....	57
Operator Commands.....	57
Event Log .....	58
Contact ID & SIA Event Log Codes .....	58
<b>Testing the System</b> .....	59
Test Modes .....	59
Testing the System .....	59
Armed System Test.....	59
Dialer Test.....	59
Zone Discovery Mode .....	60
Rebooting the System .....	60
<b>LYNX Touch Programming Default Tables</b> .....	61
<b>LYNX Touch SIA Programming Default Tables</b> .....	64
<b>Zone Programming Default Tables</b> .....	66
<b>Regulatory Agency Statements</b> .....	68
<b>Limitations of this System Statement</b> .....	69
<b>UL Notices</b> .....	70
<b>SIA Quick Reference Guide</b> .....	71
<b>Specifications</b> .....	72
<b>Contacting Technical Support</b> .....	73
<b>Glossary</b> .....	74
<b>Index</b> .....	77
<b>Summary of Connections Diagram</b> .....	79
<b>Warranty Information</b> .....	Rear Cover

## **System Features**

The LYNX Touch control is a self-contained, rechargeable wireless control/communicator that features easy installation and usage. A built-in speaker provides voice annunciation of system status along with voice descriptors of each zone. An internal module (if provided) allows the LYNX Touch to communicate with the Central Station via the Internet or GSM Cellular Wireless.



**LYNX Touch is not intended for UL985 Household Fire applications unless a 24-hour backup battery (P/N 300-03866/LYNXRCHKIT-SHA) is installed.**

### **Features**

#### **System Features**

- 4.7-inch color graphic touch screen
- Message center (for user recorded messages)
- Voice announcement of system and zone status
- Voice chime
- Reminders
- Automatic stay arming
- Remote phone control
- Speaker phone operation
- "Follow me" reminder and system announcements
- 16 User Codes (Installer, Master, Babysitter, Duress)
- 3 Panic Functions
- 16 Programmable reminders
- Up to 20 Programmable scheduled events, rules and scenes.
- Control Z-Wave Home Automation devices (requires installation of a Communications Module). Control up to:
  - 3 thermostats
  - 4 door locks
  - 40 devices (outlets, switches, lamps/appliances)
- Supports up to four Mobile Internet Devices (MID) (WiFi Tablet) (Duplicates functions of the LYNX Touch i.e.; Security, Web Content and Z-Wave control)

#### **Zones and Devices**

- 64 total zones including 1 Hardwire (EOLR, N/C, N/O) zone and up to 63 wireless zones (5800 Series transmitters)
- 2 Resident Monitor Zone Types
- Supports wireless keypads
- Built-in Case tamper

#### **Communication**

- ADEMCO Contact ID
- SIA (DC-03)
- Internet central station communication
- GSM cellular central station communication
- WiFi Central station communication
- Two-way voice communication
- Supports AlarmNet remote services

#### **System Power**

- Primary Power: Plug-in Power Supply, 110VAC to 9VDC, 2.7A output 300-04705 or 300-04065 (300-04063 in Canada)
- Backup battery: Rechargeable nickel-metal hydride battery pack rated at 7.2Vdc. (P/N 300-03864-1/LYNXRCHKIT-SC or 300-03866/LYNXRCHKIT-SHA)

#### **Alarm Output**

- Built-in sounder
- Steady output for burglary/panic
- Temporal (3) pulse output for fire alarms
- Temporal (4) pulse output for carbon monoxide alarms
- Long range radio (GSM)/audio alarm verification
- Trigger output

#### **Programming**

- Options stored in EEROM
- Can be uploaded, downloaded or controlled via IBM-compatible computer using Compass downloader software and specified HAYES or Honeywell CIA modem or via capable GSM, IP or WiFi communications module
- Flash downloading

#### **Other Features**

- Exit error feature (detects difference between an actual alarm and exit alarm caused by leaving a door open after the exit delay expires)
- Event log stores up to 128 events
- RF jam detection
- Two installer programmable user (Follow Me) phone numbers
- Advanced Protection Logic (APL) (Minimizes the likelihood of the system being disabled before notification can be sent to the Central Station indicating that the premise has been compromised.)
- Displays web content including Local News, Weather and Traffic (requires Total Connect Service)
- Dealer/Central Station messages (requires Total Connect Service)

## Mounting the Control

### Wall Mounting

1. Release the front case from the back case by depressing the two locking tabs at the top of the unit with the blade of a medium size screwdriver.
2. Separate the front and back case assemblies by rotating the front case so that it is perpendicular to the back case and unsnapping (releasing) the two hooks from the back case.
3. Feed the field wiring through the appropriate openings in the back case. Use tie-wraps to secure the wiring to the built-in wire loops as needed.
4. Mount the back case to a sturdy wall using self tapping screws.
5. If required, install an additional mounting screw in the case tamper (see Detail A).
6. Attach the front and back cases by connecting the hooks on the front case to the attachments on the back case. Once attached, the hooks will support the front case and allow you to make the wiring connections.
7. After all wiring connections have been made, snap the front case and back case closed and ensure that the case is secured by the locking tabs.

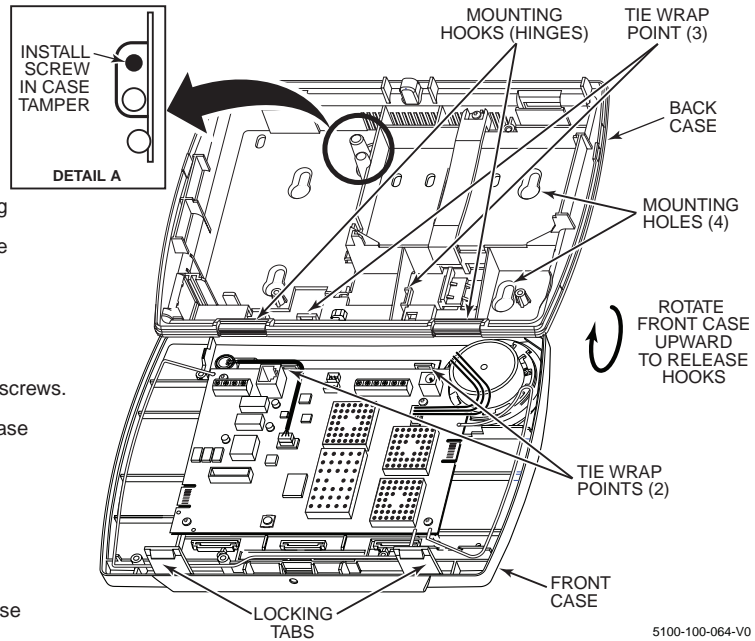

5100-100-064-V0

### Desktop Mounting

For desktop mounting, the optional mounting base (model L5000DM, purchased separately) must be used.

1. Slide the control panel onto the mounting base locking tabs.
2. Bring all wiring through the bottom of the mounting base, using one of the wire entry locations, before making connections to the control panel.
3. Use tie-wraps to secure the wiring to the built-in wire loops as needed.
4. Use the supplied screws to secure the control panel to the mounting base.

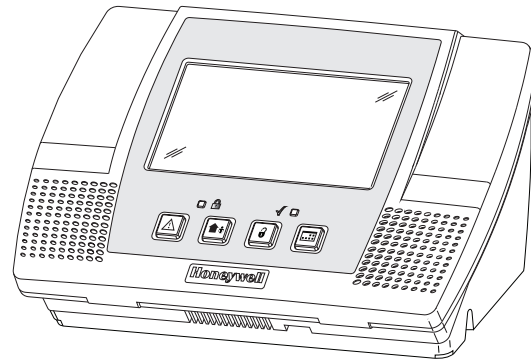

5100-100-061-V0

### Wiring Overview

The following summarizes the connections required. Refer to the Wiring Connections paragraph and the Summary of Connections diagram on the inside back cover when making connections.

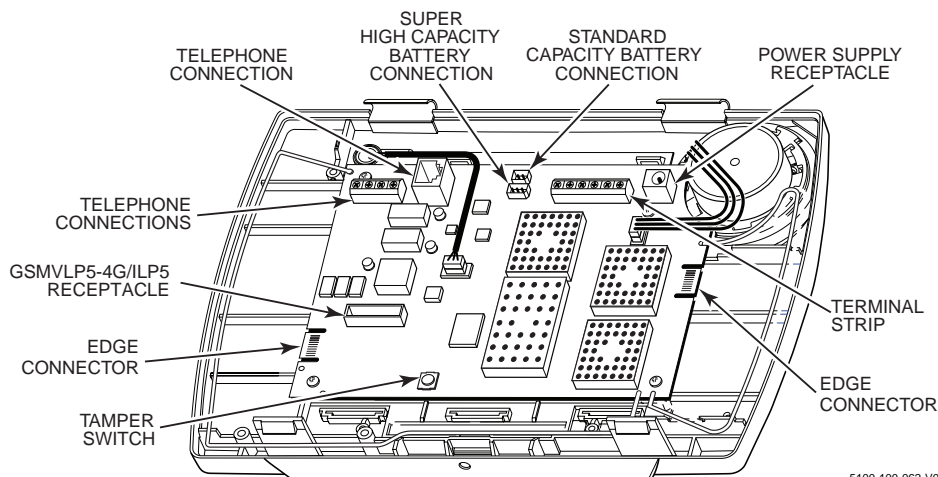

5100-100-062-V0

## Wiring Connections

1. **Make Earth Ground Connection** - The designated earth ground terminal EGND must be terminated in a good earth ground for the lightning transient protective devices in this product to be effective. The following are examples of good earth grounds available at most installations:

**Metal Cold Water Pipe** - Secure a non-corrosive metal strap (copper is recommended) to the pipe that is electrically connected and secured to which the ground lead is electrically connected and secured.

**AC Power Outlet Ground** - Available from 3-prong, 120VAC power outlets only. To test the integrity of the ground terminal, use a three-wire circuit tester with neon lamp indicators, such as the UL Listed Ideal Model 61-035, or equivalent, available at most electrical supply stores.

- a. Connect terminal EGND to a good earth ground as shown on the Summary of Connections.

2. **Make Phone Line Connections** - For local or full line seizure follow the appropriate steps below.

**Local Seizure**

- a. Connect the incoming phone line to either the 8 position jack or terminals TIP and RING on the LYNX Touch as shown on the Summary of Connections.
- b. Connect the handset phone lines to terminals H/S T (TIP) and H/S R (RING) as shown on the Summary of Connections. terminals as shown in the diagram or plug into the 8-position

**Full Line Seizure:** The control must be placed in series with the incoming phone line. Plugging the Direct Connect Cord directly into the RJ31X jack, allows the control to seize the phone line when an alarm occurs and normal phone line usage by the premises phones if the plug needs to be removed.

- c. Cut the incoming RING and TIP phone lines (typically red and green, respectively) and connect them to RJ31X terminals 4 (red) and 5 (green).
- d. Connect the premises end of the cut RING and TIP wires to RJ31X terminals 1 (grey) and 8 (brown) respectively.
- e. Wire the flying leads of a Direct Connect Cord to the control's phone terminals as shown in the diagram or plug into the 8-position jack.
- f. Plug the Direct Connect Cord into the RJ31X jack.



**HARDWIRED ZONE:** If the EOLR is not at the end of the loop, the zone will not be properly supervised, and the system may not respond to an open circuit on the zone.

3. **Hardwired Zone Connections** - One EOLR supervised zone supports both open circuit and closed circuit devices and has a response time of 350msec. Maximum zone resistance: 300 ohms, plus EOLR

**Note:** The hardwire zone cannot be used as a fire zone.

- a. Connect sensors/contacts to the hardwired zone terminals GND (-) and HWZ1 (+). Refer to the Summary of Connections diagram.
- b. Connect closed circuit devices in series in the high (+) side of the loop. The EOL resistor must be connected in series with the devices, following the last device.
- c. Connect open circuit devices in parallel across the loop. The 2000-ohm EOLR must be connected across the loop at the last device.

4. **AC Power Connections** - Connect the Power Supply to the receptacle on the LYNX Touch.

OR  
Connect wires from the Power Supply to +9VDC and EGND terminals as shown on the summary of connections diagram.

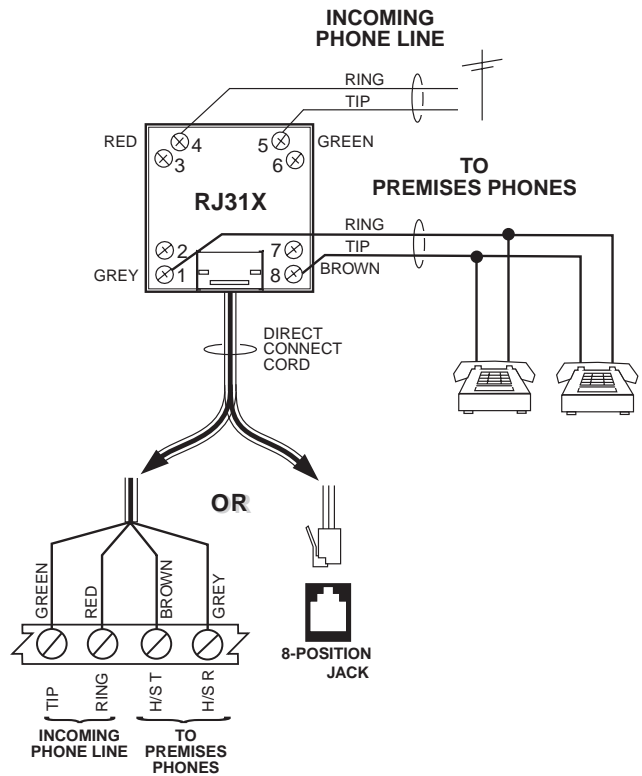

**FULL LINE SEIZURE CONNECTIONS**

**WIRING TABLE**

MAXIMUM DISTANCE BETWEEN POWER SUPPLY AND CONTROL	WIRE GAUGE
Up to 11 feet	# 22
Up to 20 feet	# 20
Up to 26 feet	# 18

5000-100-094-V2

## **Wiring Connections**

### **Installing the L5000-RJ31X in the LYNX Touch Control**

An auxiliary L5000-RJ31X receptacle can be installed in the LYNX Touch that will allow the telephone cable to be disconnected without requiring the unit to be opened up.

1. Using a wire cutter or knife cut the plastic tabs that secure the receptacle knockout from the left side of the LYNX Touch back case.
2. Connect four wires between the L5000-RJ31X receptacle terminal strip and the incoming phone line and the premises telephones as shown on the figure below.
3. Install the L5000-RJ31X receptacle into the slot on the back case.
4. Connect one end of the L5000-RJ31X cable to the 8-position jack on the LYNX Touch PC board.
5. Route the cable through the opening in the back case and along the wire channel in the back case.
6. Connect the other end of the cable to the L5000-RJ31X receptacle on the side of the back case as shown below.
7. Secure the wires to the tie wrap points on LYNX Touch front and back case with the provided tie wraps.



**To allow flush wall or desk mounting of the control, ensure that L5000-RJ31X cable is routed through the channel in the case back. Ensure enough slack is left in the wires to allow the case to close without pinching the wires.**

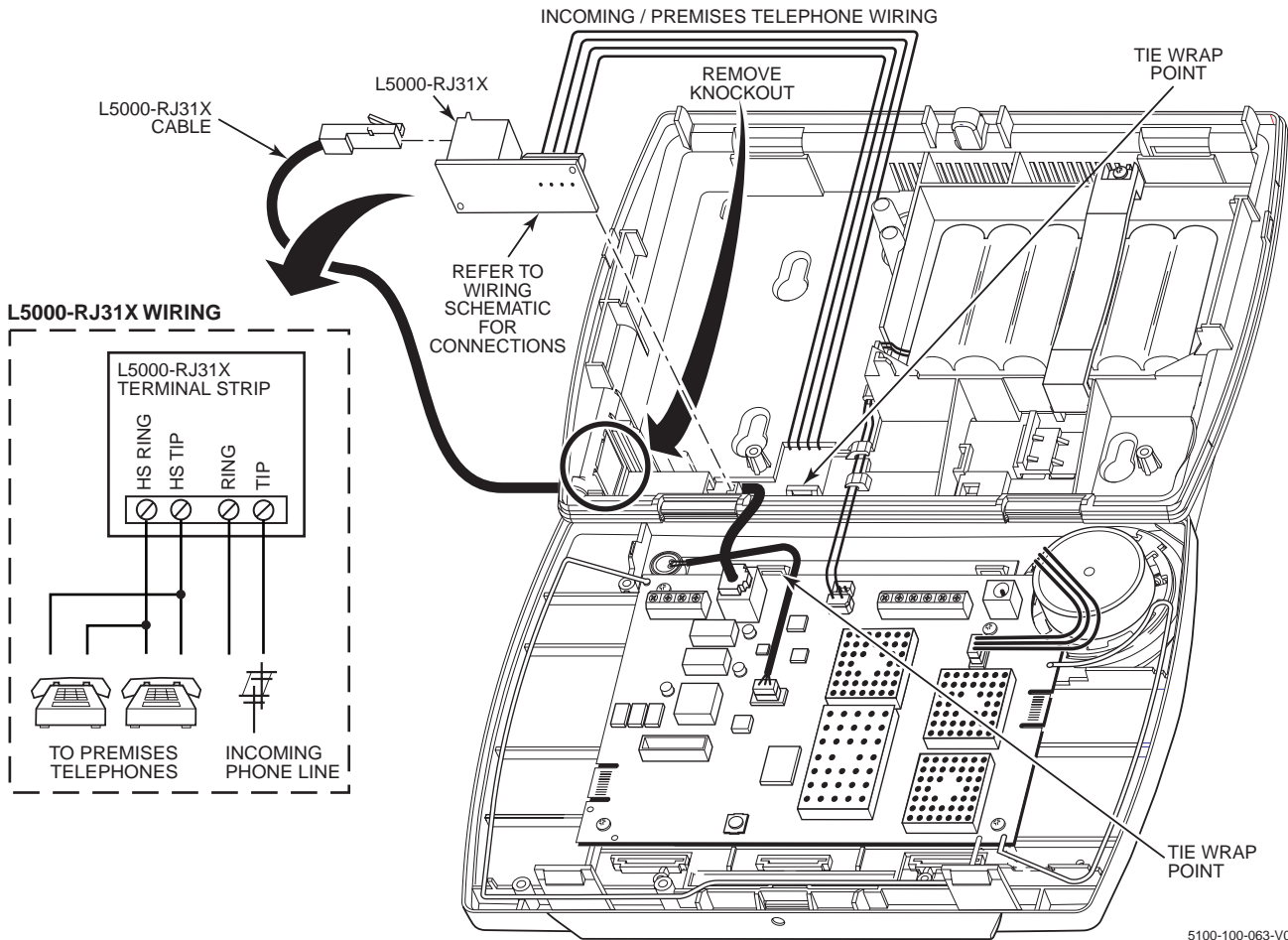



## AC Power and Backup Battery

The system is powered by a 9 Volt DC, 2.7 Amp Plug-in Power Supply, 300-04705 or 300-04065 (300-04063 in Canada). Refer to the wiring table below for wire gauge and length. In the event of an AC power loss, the system is supported by a long life backup battery that is supervised for connection and for low voltage conditions. If the battery is missing, or a low battery condition is detected, a "low battery" message is displayed and a report is sent to the central station. In addition, the system will beep once every 45 seconds to audibly indicate a low battery condition (press any key to stop the beeping).



**Use only the provided 300-04705 or 300-04065 (300-04063 Canada) Power Supply. Do not plug the power supply into the AC outlet until after all wiring connections have been made. Ensure the cover is snapped closed prior to applying AC power**

The LYNX Touch is equipped with an integral, replaceable, rechargeable battery pack rated at 7.2Vdc. Select the appropriate battery pack, based on the installation's requirement, and install the battery pack.

### Installing the Rechargeable Backup Battery

1. Remove battery retainer.
2. Insert battery pack into back case.
3. Route cable through channel (cutout) on left side of compartment.
4. Install battery retainer.
5. Secure battery retainer with the provided screw.
6. Secure battery wiring in the wire routing clips (3).
7. Connect the battery connector to the receptacle on the PC board.
8. After the wiring connection has been made, snap the front and the back case closed.
9. Plug the power supply into a 24-hour, 110VAC unswitched outlet. Upon powerup, the system will display "Please Wait Checking System Integrity".

### Replacing the Rechargeable Backup Battery

1. When battery replacement is required, unplug the transformer from the wall outlet, and open the control panel cover.
2. Remove the screw that secures the battery retainer.
3. Remove the battery retainer and disconnect the battery pack connector from the receptacle on the PC Board.
4. Remove the battery pack from the back case.
5. Install a replacement battery pack (P/N 300-03864-1/ LYNXRCHKIT-SC or P/N 300-03866/ LYNXRCHKIT-SHA) into the back case.
6. Route cable through channel (cutout) on left side of compartment.
7. Install the battery retainer.
8. Secure battery retainer with the provided screw. Secure battery wiring in the wire routing clips (3).
9. Connect the battery connector to the receptacle on the PC board.
10. After the wiring connection has been made, snap the front and the back case closed.
11. Plug the power supply into a 24-hour, 110VAC unswitched outlet. Upon powerup, the system will display "Please Wait Checking System Integrity".

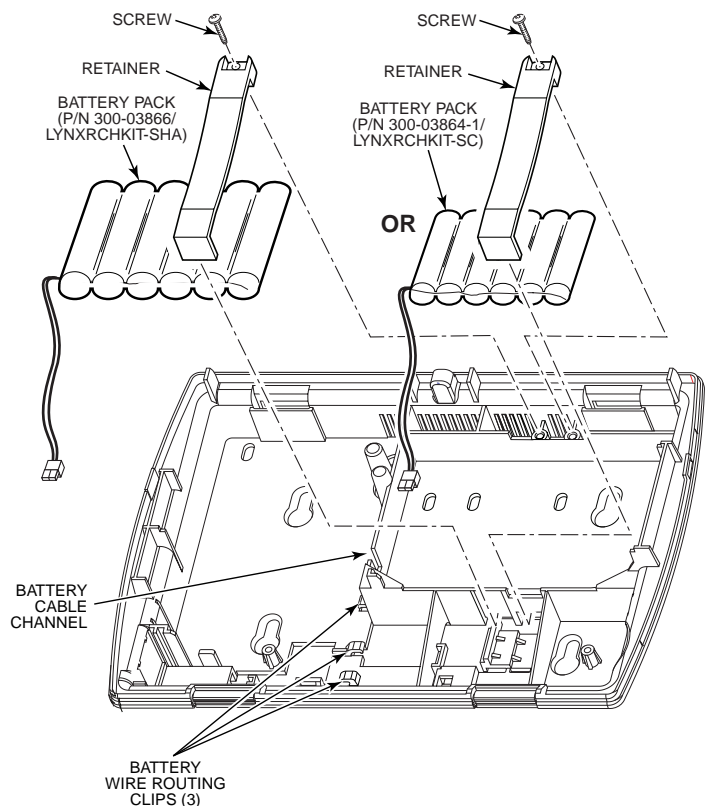

### Battery Selection

The LYNX Touch is equipped with an integral, replaceable, rechargeable battery pack rated at 7.2Vdc. Select the appropriate battery pack, based on the installation's requirement, and install the battery pack.

Battery Part Number	Battery StandbyTime	Low Battery Notification
300-03864-1/ LYNXRCHKIT-SC	4-hours (minimum)	Approximately 1-hour before battery depletion
300-03866/ LYNXRCHKIT-SHA	24-hours (minimum)	At least 1-hour before battery depletion



**Ensure the control panel assembly is snapped closed prior to applying AC power. Rechargeable batteries may take up to 48-hours to fully charge. The "Low Battery" message should clear within four hours or by entering an OFF sequence.**

## Installing/Configuring Communication & Home Automation Modules

### General

This LYNX Touch control supports central station reporting using wireless (GSM) and hardwire (IP) communications modules. It also supports upload/download programming capability via the Internet or a Private local area network (Intranet). This allows site maintenance independent of central station monitoring, and modification to sites globally via the Internet or through a private LAN. Refer to the instructions provided with the LRR/IP Communications Module being installed for additional information regarding its installation, programming, and registration. The control is compatible with the following AlarmNet Communications Modules:

- GSMVLP5-4G/GSMVLP5CN4G GSM Communication Module
- ILP5 Ethernet Communications Module

### Communications Module 24-Hour Standby Power

If you require 24-hour standby, you must install the Super High Capacity battery P/N LYNX-RCHB-SHA in the control.



#### RF Exposure

WARNING: The LYNX Touch must be installed to provide a separation distance of at least 7.8 in (20 cm) from all persons and not co-located or operated in conjunction with any other transmitter except in accordance with FCC multi-transmitter product procedures.

## Connecting and Configuring Communication Modules

Connect and configure the communications module as follows:

### Installing the GSMVLP5-4G/GSMVLP5CN4G



Ensure that **SIM card and the connector board** are securely installed in the **GSMVLP5-4G/GSMVLP5CN4G** before installing the communications module in the LYNX Touch.

1. Install the GSMVLP5-4G/GSMVLP5CN4G into the LYNX Touch control front case. Ensure that the connector board is properly seated into the receptacle on the control.
2. Secure the GSMVLP5-4G/GSMVLP5CN4G with the three provided screws.
3. Enable the GSMVLP5-4G/GSMVLP5CN4G device, configure alarm reporting and module supervision and register the device. Refer to the "Program the Communications Module" and "Communications Diagnostics" sections.



The communications module must be registered with AlarmNet before downloading or alarm reporting can take place.

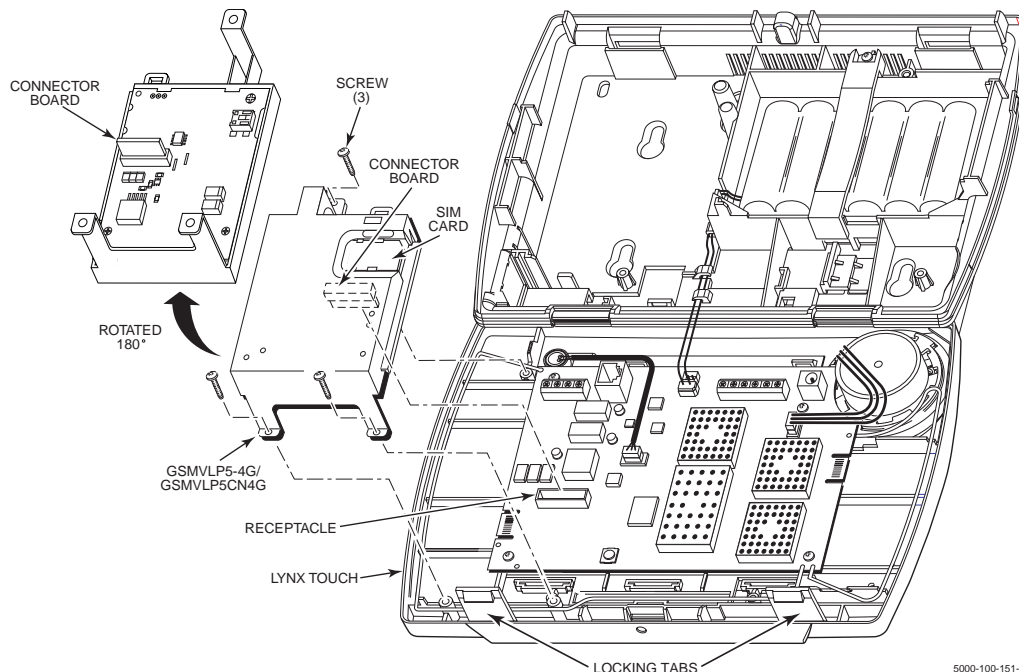

5000-100-151-V2

## Installing/Configuring Communication & Home Automation Modules

### Installing the ILP5



**Do not install the ILP5 if the L5100-WiFi communications module is being installed.**

**Ensure that the connector board and cable are securely installed in the ILP5 before installing the communications module in the LYNX Touch.**

1. Using a wire cutter or knife cut the plastic tabs that secure the ILP5 spacer from to the back case of the LYNX Touch.
2. Remove the ILP5 receptacle knockout from the left side of the LYNX Touch back case.
3. Install the ILP5 into the LYNX Touch control front case. Ensure that the connector board is properly seated into the receptacle on the control.
4. Secure the ILP5 with the three provided screws.
5. Insert the ILP5 receptacle and spacer into the slot on the back case.
6. Secure the communications cable to the tie wrap point on the ILP5 with the provided tie wrap.
7. Connect the Ethernet cable to the RJ45 receptacle.
8. Enable the ILP5 and configure alarm reporting and module supervision and register the device. Refer to the "Program the Communications Module" and "Communications Diagnostics" sections.

### Alternate Installation (Refer to the Alternate Installation as shown on the figure below)

1. Install the ILP5 into the LYNX Touch control front case. Ensure that the connector board is properly seated into the receptacle on the control.
2. Secure the ILP5 with the three provided screws.
3. Insert the ILP5 receptacle into the slot on the back case as shown on the figure below.
4. Secure the communications cable to the tie wrap point on the ILP5 with the provided tie wrap.
5. Connect the Ethernet cable to the RJ45 receptacle.
6. Enable the ILP5 and configure alarm reporting and module supervision and register the device. Refer to the "Program the Communications Module" and "Communications "Diagnostics" sections.



**The communications module must be registered with AlarmNet before downloading or alarm reporting can take place.**

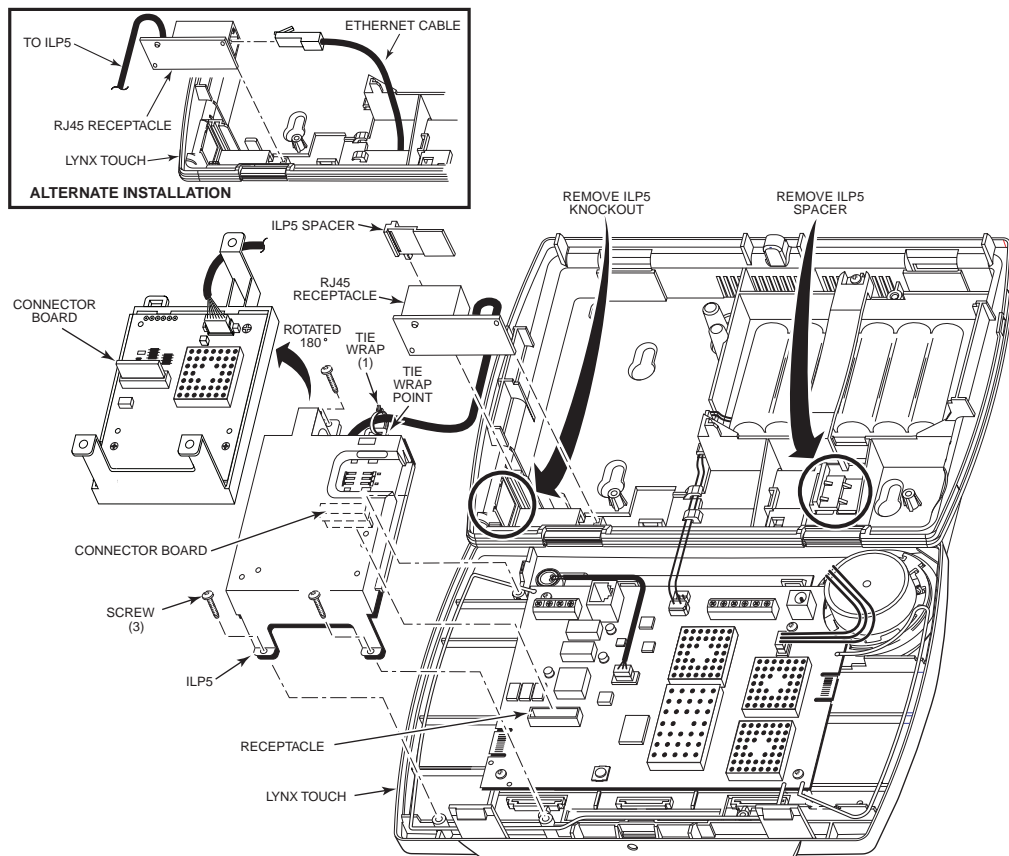

5100-100-065-V0

## **Installing/Configuring Communication & Home Automation Modules**

### **Installing the L5100-WiFi module**



**Do not install the L5100-WiFi if the ILP5 Ethernet communications module is being installed.**

1. Install the L5100-WiFi into the LYNX Touch control front case as shown below. Ensure that the receptacle is properly seated into the edge connector on the right (speaker) side of the control's circuit board.
2. Enable the L5100-WiFi module, configure alarm reporting and module supervision and register the device. Refer to the "Program the Communications Module" and "Communications Diagnostics" sections.



**The communications module must be registered with AlarmNet before downloading or alarm reporting can take place.**

### **Installing the L5100-ZWAVE Home Automation module**

1. Enable the L5100-ZWAVE module. Refer to the "Program the Z-Wave Module".
2. Install the L5100-ZWAVE into the LYNX Touch control front case as shown below. Ensure that the receptacle is properly seated into the edge connector on the left (TELCO terminal) side of the control's circuit board.

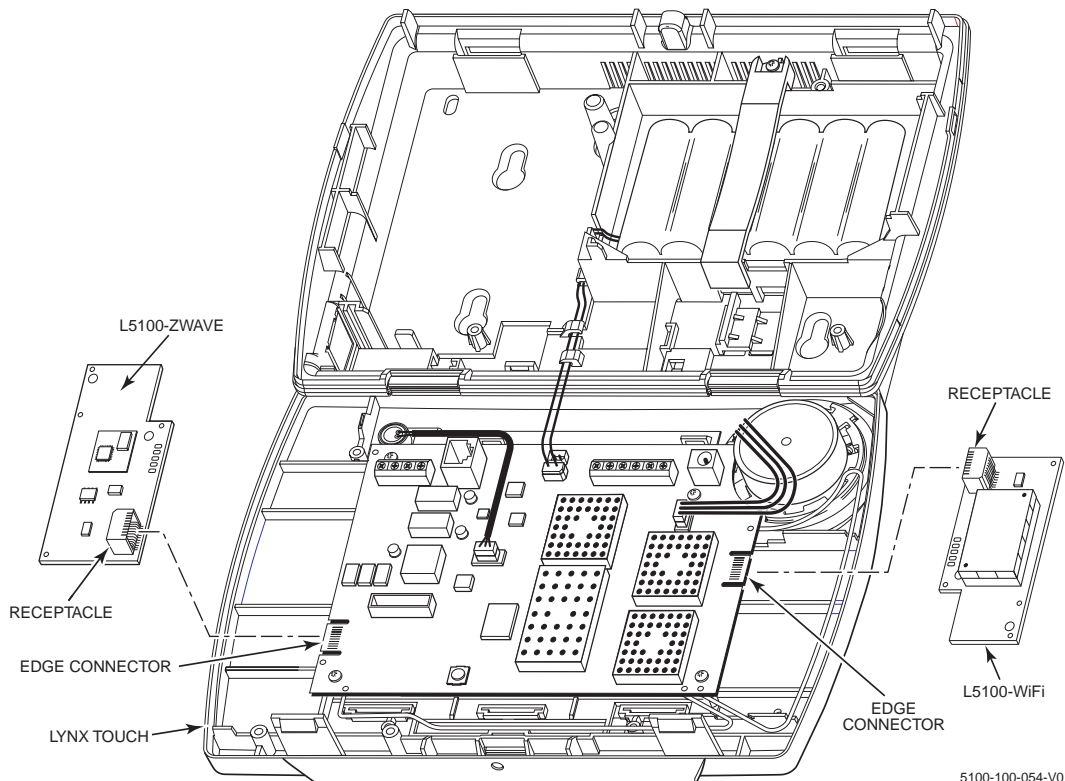

## Installing Wireless Zones

### General Information

#### Zones

The control supports up to 63 total wireless zones using 5800 Series transmitters, and wireless buttons.

#### Range

The built-in RF receiver can detect signals from wireless transmitters within a nominal range of 200 feet.

#### Transmitters

5800 Series transmitters have built-in serial numbers that must be entered into the system using the "Zones" programming section, or input to the control via the downloader. 5800 Series transmitters (except the 5800RL) do not have DIP switches. Each transmitter's zone number is also programmed into the system in the "Zones" programming section. Some transmitters, such as the 5816 and 5817, can support more than one "zone" (referred to as loops or inputs). On the 5816, for example, the wire connection terminal block is loop 1; the reed contact is loop 2. Each loop must be assigned a different zone number.

For button transmitters (RF "keys") such as the 5804, you must assign a unique zone number to each individual button used on the transmitter. Each button on the transmitter also has a pre-designated loop or input number, which is automatically displayed.

---

**UL** The 5816 and 5817 Transmitters do not have EOL supervision of their loop wiring, which must not exceed 3 feet. The 5800RL, 5802MN, 5802MN2, 5804, 5804BD, 5804BDV, 5804E, 5814, 5816TEMP, 5819, 5819S(WHS & BRS), 5828/5828V and 5850(GBD) transmitters have not been evaluated by UL.

---

#### House Identification

If you are using a 5804BD/5804BDV Wireless Keypad with the system, you must program a House ID Code (01–31) as described in the "SYSTEM TYPE" programming section to establish proper communication, and the keypad must be set to the same ID. House ID 00 disables all wireless keypads. An RF House ID is not necessary for other 5800 Series transmitters; the entry should be left at "00" (default) in those cases.

#### Transmitter Supervision

With the exception of some transmitters/keypads that may be carried off-premises (5804, 5804BD, 5804BDV, 5804E and 5805-6), each transmitter is supervised by a check-in signal that is sent to the receiver at 70–90 minute intervals. If at least one check-in is not received from each supervised transmitter within a 12-hour period, the "missing" transmitter zone number(s) and "Supervision" will be displayed. The supervision for a particular transmitter in the system that may also be carried off the premises (5802/5802MN2, 5802MN) may be turned off by entering it as a Unsupervised RF (UR) type, as described in the "ZONES" programming section. 5800 Series transmitters have built-in tamper protection and will announce as a fault condition if covers are removed.

#### Transmitter Input Types

Each of the transmitters has one or more unique factory-assigned input (loop) ID codes. Each of the inputs requires a programming zone (e.g., a 5804's four inputs require four button zones). Transmitters can be entered as one of the following types (see transmitter's instructions for appropriate input type):

Type	Description
Supervised RF ("RF")	Sends periodic check-in signals, as well as fault, restore, and low battery signals. The transmitter must remain within the receiver's range.
Unsupervised RF ("UR")	Sends all the signals that the "RF" type does, but the control does not supervise the check-in signals. The transmitter may therefore be carried off-premises.
Unsupervised Button RF ("BR")	Sends only fault signals. They do not send low battery signals until they are activated. The transmitter may be carried off-premises.



#### Transmitter Battery Life

- Batteries in the wireless transmitters may last from 4–7 years, depending on the environment, usage, and the specific wireless device being used. Factors such as humidity, high or low temperatures, as well as large swings in temperature may all reduce the actual battery life in a given installation. The wireless system can identify a true low battery situation, thus allowing the dealer or user of the system time to arrange a change of battery and maintain protection for that point within the system.
- Button-type transmitters should be periodically tested for battery life. The 5802MN, 5802MN2, 5804, 5804BD, 5804BDV, and 5804E button transmitters have replaceable batteries.

## Installing Wireless Zones

### RF Sniffer Test Mode

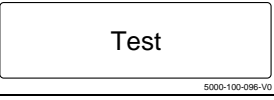
This mode is used after all transmitters have been entered to check that all transmitters have been properly programmed. Sniffer mode does not automatically expire. You must manually exit Sniffer mode by selecting Off and entering the Installer Code to return to normal operation.

SCREEN	ACTION				
	1. At the Tools Screen, select "Test". The following options are displayed. <table style="width: 100%; border: none;"> <tr> <td style="width: 50%; border: none;">Walk Test</td> <td style="width: 50%; border: none;">RF Sniffer Test</td> </tr> <tr> <td style="border: none;">Go-No-Go Test</td> <td style="border: none;">Dialer Test</td> </tr> </table>	Walk Test	RF Sniffer Test	Go-No-Go Test	Dialer Test
Walk Test	RF Sniffer Test				
Go-No-Go Test	Dialer Test				
	2. Select "RF Sniffer Test" from the options. <b>Note:</b> If the communicator is in the process of sending a report to the central station, the system will not go into the Sniffer mode. If so, wait a few minutes and try again. 3. The system displays all programmed zone numbers and zone descriptors, which have a non-zero Zone Type. Fault each transmitter in turn, causing each one to send a signal. As the system receives a signal from each of the transmitters, the zone number of that transmitter disappears from the display. The transmitters may be checked upon installation, or in an installed system. The system will beep once every 30-40 seconds while the RF Sniffer Test mode is active. 4. When all transmitters have been checked, Exit RF Sniffer Test mode by depressing the Off key and entering the Installer or a User Code.				

- Notes:**
- (1) All button-type (BR) units must physically be activated to clear the display, since they do not automatically send check-in signals.
  - (2) When one button of a button type, supervised or unsupervised RF transmitter (RF, UR, or BR) is activated, all zones assigned to other buttons on that transmitter are cleared. This also applies to 5816 and 5817 transmitters that have multiple loops (zones).
  - (3) Any transmitter that is not "entered" will not turn off its zone number.
  - (4) For SIA installations, the following devices may be used as specified for panic (24-hour) alarm response:
    - wireless keys which have two-button panic pairs available (e.g., 5804BDV), on which only the two-button panic pairs may be programmed for any 24-hour alarm response
    - wireless keypads (e.g., 5828/5828V) keypads that have a two-second delay on the special function keys, or two-button panic pairs
    - built-in keypad panic key

### Go/No Go Test Mode



**Conducting this test with your hand wrapped around the transmitter will cause inaccurate results. On button type transmitters that have been programmed to set ARM AWAY, ARM STAY, or DISARM, pressing a button will take the system out of the Go/No Go Test mode causing the programmed action to occur.**

The Go/No Go tests will verify adequate RF signal strength from the proposed transmitter location, and allow you to reorient or relocate transmitters if necessary, before mounting the transmitters permanently. This mode is similar to the transmitter Test mode, except that the wireless receiver gain is reduced. This will enable you to make sure that the RF signal from each transmitter is received with sufficient signal amplitude when the system is in the normal operating mode.

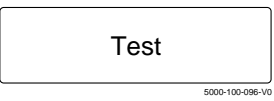
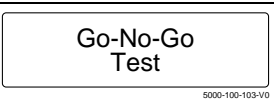
SCREEN	ACTION				
	1. At the Tools Screen, select "Test". The following options are displayed. <table style="width: 100%; border: none;"> <tr> <td style="width: 50%; border: none;">Walk Test</td> <td style="width: 50%; border: none;">RF Sniffer Test</td> </tr> <tr> <td style="border: none;">Go-No-Go Test</td> <td style="border: none;">Dialer Test</td> </tr> </table>	Walk Test	RF Sniffer Test	Go-No-Go Test	Dialer Test
Walk Test	RF Sniffer Test				
Go-No-Go Test	Dialer Test				
	2. Select "Go-No-Go Test". 3. Once you have placed transmitters in their desired locations, and the approximate length of wire to be run to sensors is connected to the transmitter's screw terminals (if used), fault each transmitter. <ol style="list-style-type: none"> <li>a. The keypad beeps three times indicating signal reception, displays the appropriate zone number and announced the zone description.</li> <li>b. If the keypad does not beep, reorient or move the transmitter to another location. Usually a few inches in either direction is all that is required.</li> </ol> 4. If each transmitter produces the proper keypad response when faulted, they can be permanently mounted according to their respective instructions. 5. The system will beep once every 30-40 seconds while the Go-No-Go Test mode is active. 6. Exit Go-No-Go Test mode by depressing the Off key and entering the Installer or a User Code.				

## Installing Wireless Zones

### 5800 Series Transmitter Loop Numbers

(Refer to this information when programming transmitters)

The following illustration shows the compatible transmitters, their associated input types and loop designations.

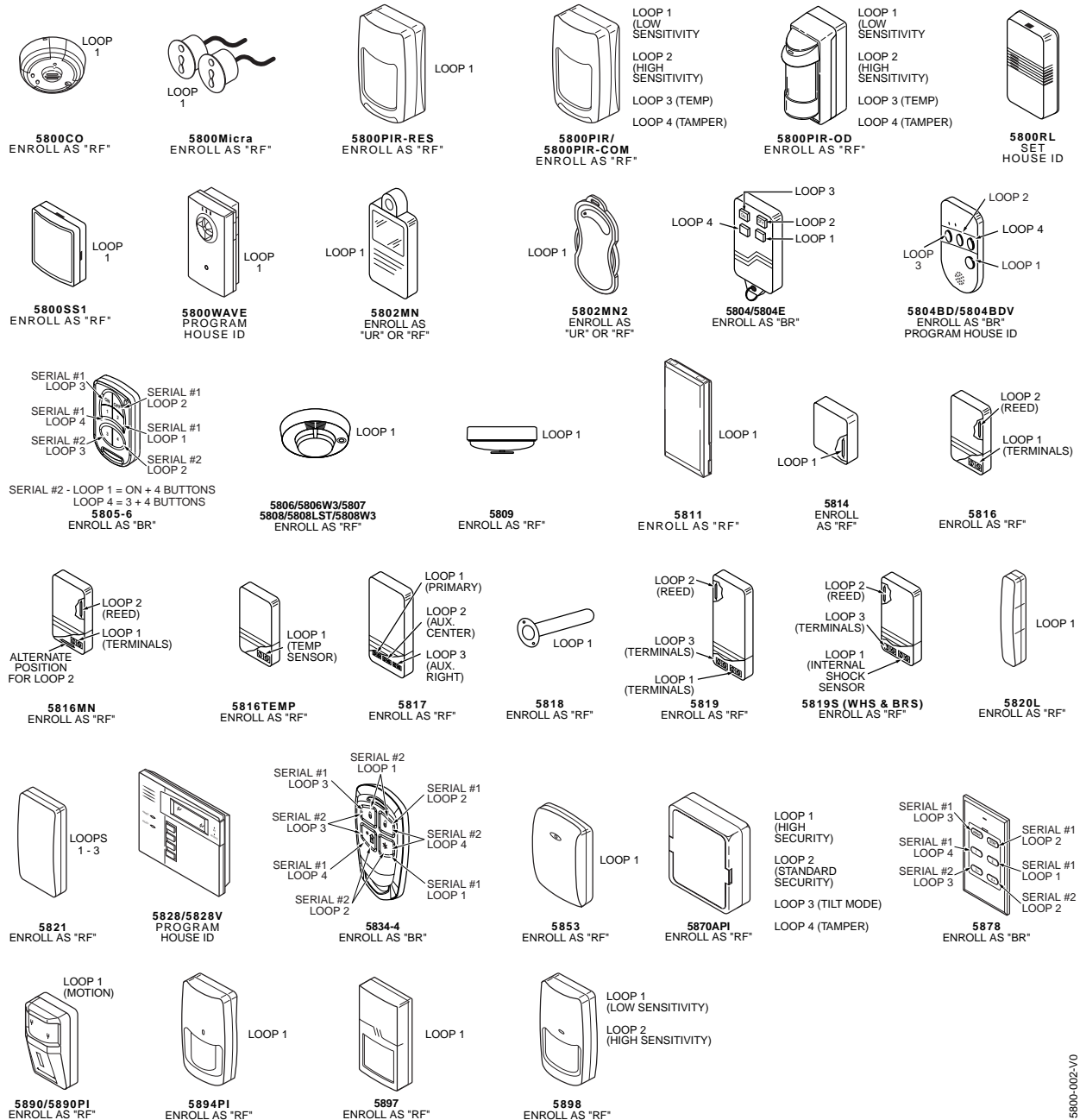

- Notes:**
- (1) The 5806W3 smoke detector must be used in SIA applications.
  - (2) Button type (BR) devices send only fault and low battery signals; no restore or check-in signals. Supervised RF (RF) devices send periodic check-in signals, faults, restore and low battery signals. Unsupervised RF (UR) devices send periodic check-in signals, faults, restore and low battery signals but the control does not supervise the check-in signals.
  - (3) If an external sounder is required, the 5800WAVE should be used.



The 5800RL, 5802MN, 5802MN2, 5804, 5804BD, 5804BDV, 5814, 5816TEMP, 5819, 5819S(WHS & BRS), and 5828/5828V wireless transmitters have not been evaluated by UL.

## Mechanics of Programming

### Navigating Menus

#### Touch-screen Display

LYNX Touch’s Liquid Crystal Display (LCD) touch-screen displays variable icons and text on “screens”. The screen displays status icons and associated text, the current time and date, system status information and menu choices. The Menu area includes a list of commands, or choices that apply to the current selection. The status area provides information about various system events and a colored bar also provides an indication of system status. A “Home Screen” is displayed whenever power is applied to the system. In addition the Green (Ready) LED is lit when the system is ready or flashes when it is not. The Red (Armed) LED is lit when the system is Armed.

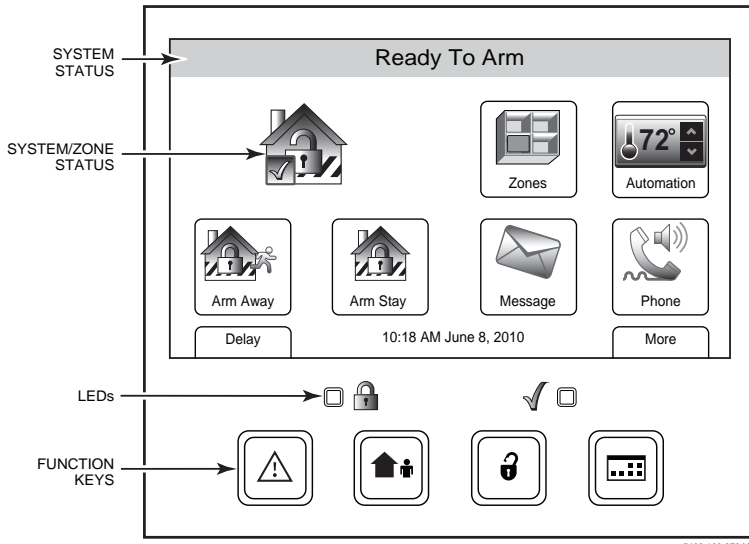

Home Screen (page 1)

#### Function Keys

	<b>Panic key</b> Initiates panic alarm options when depressed for 4 seconds.
	<b>Away key</b> Initiates Arm Away option.
	<b>Off (Disarm) key</b> Initiates disarm process.
	<b>Home key</b> Used to exit from a screen or return to the home screen.

#### Navigation Keys

Navigating through the screens is accomplished by lightly touching the menu item on the touch-screen. Once activated, the control will take you to the next screen. Selecting the “Home” (cancel) key or the “↶” Key will return you to the previous screen at any time unless System Programming mode is active. By Touching (selecting) an icon or key the system, depending on the function, advances to another screen, toggles between options or scrolls through multiple options that can be selected. The system provides a prompt when a specific input is required.

**Note:** You may find it convenient to adjust the volume setting before entering the Program Mode. This will allow you to clearly hear the feedback announcements or system beeps from the system’s built-in speaker. To adjust the volume, select “More” on the “Home Screen” and then select “Settings”. Adjust the volume using the slide displayed on the Settings screen and then select “Save” to accept. Upon exiting the Program Mode, the system resets the volume to the default value (mid level).

#### Dashboard Screen

When Total Connect Services are connected and web content is enabled, the Home Screen is replaced by the Dashboard Screen. System Status is displayed at the top of each screen. In addition to the system status, the Dashboard Screen displays time and date, weather and five selection “buttons”.



Selection	Function
Security	Provides access to Security Menu.
Notices *	Provides access to Notices page.
Automation *	Provides access to Automation page.
News *	Provides access to News page.
Traffic *	Provides access to Traffic page.

\* Requires Total Connect Services



## Mechanics of Programming

### Security Menu Screens

System Status is displayed at the top of each screen. The time and date are displayed at the bottom of the Home Screen. The Security Home Screen consists of two pages. The first page displays the system status and eight selection “buttons” and “tabs”. The displayed pages and options may vary slightly depending upon the devices and services that are installed in or connected to the system.

Selection	Function
Zones	Provides access to Zone information and options.
Automation	Provides access to the Z-Wave Device and Home Automation Screen.
Arm Away	Used to Arm the system in Away mode (displayed on both Home Screen pages).
Arm Stay	Used to Arm the system in Stay mode (displayed on both Home Screen pages).
Message	Provides access to Message Center.
Phone	Provides access to Speaker Phone mode. (if programmed)
Delay/Instant	Used to toggle between exit delay and instant arming options (displayed on Home Screen pages).
More	Advances system to second page of the Home Screen.

The second page also displays the system status and seven selection “buttons” and “tabs”.

Selection	Function
System	Provides information about system status
Tools	Provides access to Installer and User Programming Menus (Master User Code required for access).
Arm Away	Used to Arm the system in Away mode (displayed on both Home Screen pages).
Arm Stay	Used to Arm the system in Stay mode (displayed on both Home Screen pages).
Dashboard	Used to return to the Dashboard Screen (displayed if connected to Total Connect Services)
Settings	Provides access to various keypad functions (i.e.; Brightness, Contrast, Volume, Voice, Chime & Ringer).
Delay/Instant	Used to toggle between exit delay and instant arming options (displayed on both Home Screen pages).
Back	Returns system to first page of the Home Screen.

### Installer Tools Menu

The Tools/Installer Menu provides access to the Installer configurable features and displays six options. Entering the Installer Code is required to access the Installer Menu.

**Note:** For information regarding the Rules, Events and Schedules programming screens, refer to the User Manual.

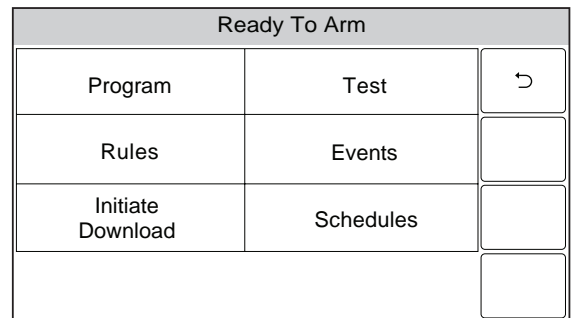

Installer Menu Page

### User Tools Menu

The User Menu provides access to the User configurable features and displays eight options. Entering the Master User Code is required to access the User Menu.

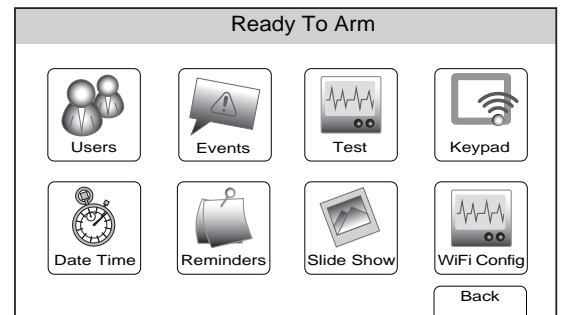

User Menu Page

## Mechanics of Programming

### General Programming Information

 When power cycling the control, remove AC power first and wait approximately 1 minute before disconnecting battery.

Programming options are stored in non-removable, electrically erasable, nonvolatile EEROM memory. The system can be programmed at any time, even at the installer's premises prior to the actual installation. Simply apply power temporarily to the Control and then program the unit as desired.

The "Initiate Download" button is used to initiate remote programming using an IBM PC compatible Personal Computer, and Compass Downloader and modem or via capable GSM or IP communications modules. See the *Remote Programming/Control (Downloading)* section for additional information.

### Programming

 If the system is Armed or in Alarm, the Tools icon will not be functional. The system must first be disarmed.

#### Enter Installer Programming Mode

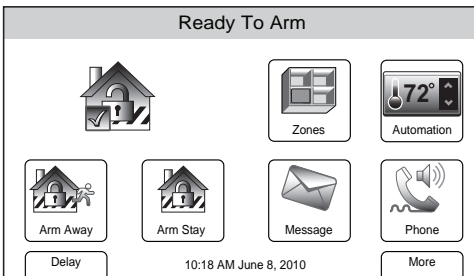
SCREEN	ACTION														
	<ol style="list-style-type: none"> <li>At the Home Screen select "More".</li> <li>Select "Tools". The touchscreen displays a keypad.</li> <li>Enter the Installer Code 4112.</li> <li>The System Programming Screen is displayed. Select "Program" to display the following options: <table border="0" style="width: 100%;"> <tr> <td style="width: 50%;">Installer Code</td> <td style="width: 50%;">System Type</td> </tr> <tr> <td>Date Time</td> <td>Communicator</td> </tr> <tr> <td>Zones</td> <td>Comm. Diagnostics</td> </tr> <tr> <td>Keys</td> <td>Reporter</td> </tr> </table> <p>Use the down ▼ arrow to scroll to the next page of options.</p> <table border="0" style="width: 100%;"> <tr> <td style="width: 50%;">Sounder</td> <td style="width: 50%;">System Settings</td> </tr> <tr> <td>Default Config.</td> <td>Language*</td> </tr> <tr> <td>Reset Master Code</td> <td>Z-Wave</td> </tr> </table> </li> <li>The system advances to the Programming screen of the selected option.</li> </ol> <p>* This programming field may not be available with the system being installed.</p>	Installer Code	System Type	Date Time	Communicator	Zones	Comm. Diagnostics	Keys	Reporter	Sounder	System Settings	Default Config.	Language*	Reset Master Code	Z-Wave
Installer Code	System Type														
Date Time	Communicator														
Zones	Comm. Diagnostics														
Keys	Reporter														
Sounder	System Settings														
Default Config.	Language*														
Reset Master Code	Z-Wave														

### Loading Factory Defaults

To load the factory defaults, enter the Installer Programming Mode and advance to second page of the System Programming and refer to following procedure. Refer to the Programming Default Tables section of this manual to view the Default Tables.

 If a default table is loaded, any data that has already been programmed into the system will be changed according to the default table selected!

#### Select a Default Configuration

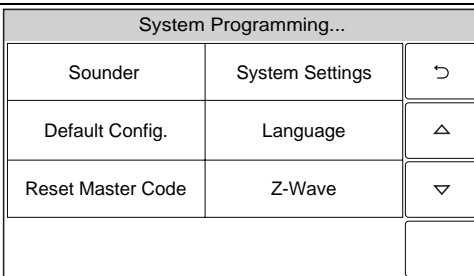
SCREEN	ACTION						
	<ol style="list-style-type: none"> <li>Select "Default Configuration" to display the following options: <table border="0" style="width: 100%;"> <tr> <td style="width: 50%;">Default Config 1</td> <td style="width: 50%;">Default Config 2</td> </tr> <tr> <td>Default Config 3</td> <td>Default Config 4</td> </tr> <tr> <td>Default Downloader</td> <td></td> </tr> </table> <p><b>Note:</b> For a list of the pre-programmed defaults refer to the Default Tables section.</p> </li> <li>Select the desired Default Configuration.</li> <li>A Confirmation screen is displayed.</li> <li>If "Yes" is selected, the System beeps three times and returns to the Default option screen.</li> <li>If "No" is selected, the System returns to the Default option screen.</li> </ol>	Default Config 1	Default Config 2	Default Config 3	Default Config 4	Default Downloader	
Default Config 1	Default Config 2						
Default Config 3	Default Config 4						
Default Downloader							

## ***Mechanics of Programming***

### **Exiting Program Mode**

1. Select the “↵” key to exit the current screen. The system returns to the previous screen.
2. Select the “↵” key as required until system displays a Confirmation screen.
3. Select “Yes” to allow the installer to re-enter Programming mode or “No” to prevent re-entry. If “No” is selected, you can still re-enter Program Mode by powering down the unit (remove AC and battery power) and entering Program Mode within 30 seconds of powering up.
4. Select the “↵” key again to return to the Home Screen.

## **Zone Response Type Definitions**

### **General Information**

During programming, you must assign a zone type to each zone, which defines the way in which the system responds to faults in that zone. Zone types are defined below.

<b>Type</b>	<b>Function</b>	<b>Characteristics</b>
Not Used	Used to program a zone that is not used.	<ul style="list-style-type: none"> <li>• None</li> </ul>
Entry/Exit 1 (Burglary)	Usually assigned to sensors or contacts on primary entry and exit doors.	<ul style="list-style-type: none"> <li>• Entry delay #1 is programmable.</li> <li>• Exit delay is independently programmable.</li> <li>• Exit and entry delays when armed in AWAY or STAY mode.</li> <li>• No entry delay when armed in STAY INSTANT or AWAY INSTANT mode.</li> <li>• Exit delay regardless of the arming mode selected.</li> </ul>
Entry/Exit 2 (Burglary)	Usually assigned to sensors or contacts on secondary entry and exit doors that might be further from the keypad (typically used for a garage, loading dock, or basement door).	<ul style="list-style-type: none"> <li>• Entry delay #2 is programmable.</li> <li>• Exit delay is independently programmable.</li> <li>• Secondary entry delay, if armed in the AWAY or STAY mode.</li> <li>• No entry delay when armed in the STAY INSTANT or AWAY INSTANT mode.</li> <li>• Exit delay begins regardless of the arming mode selected.</li> </ul>
Perimeter (Burglary)	Usually assigned to all sensors or contacts on exterior doors and windows	<ul style="list-style-type: none"> <li>• Instant alarm, when armed in AWAY, STAY, STAY NO DELAY, or AWAY INSTANT mode.</li> </ul>
Interior, Follower	Usually assigned to a zone covering an entry area (i.e.: foyer, lobby, or hallway) that one must pass upon entry (after faulting the entry/exit zone) to reach the keypad. It provides an instant alarm if the entry/exit zone is not violated first, and protects an area in the event an intruder has hidden on the premises before the system is armed, or gains access to the premises through an unprotected area.	<ul style="list-style-type: none"> <li>• Delayed alarm (using the programmed entry/exit time) if entry/exit (types 01 or 02) or interior-with-delay (type 10) zone is faulted first.</li> <li>• Instant alarm in all other situations.</li> <li>• Active when armed in AWAY or AWAY INSTANT mode.</li> <li>• Bypassed automatically when armed in STAY or STAY INSTANT mode.</li> </ul>
Trouble by Day/ Alarm by Night	Usually assigned to a zone that covers a sensitive area (i.e.: stock room, drug supply room, etc.) It can also be used on a sensor or contact in an area where immediate notification of an entry is desired.	<ul style="list-style-type: none"> <li>• Instant alarm, when armed in AWAY, STAY, STAY INSTANT, or AWAY INSTANT (night) mode.</li> <li>• Provides a latched trouble sounding from the keypad and, if desired, a central station report when disarmed (day).</li> </ul>
24-hour Silent Alarm	Usually assigned to a zone containing an Emergency button (silent emergency).	<ul style="list-style-type: none"> <li>• Sends a report to the central station but provides no keypad display or sounding.</li> <li>• In disarmed state sends a report to the central station displays "Not Ready to Arm" on the keypad and "AWAY", "STAY" and "TOOLS" buttons are disabled.</li> </ul>
24-hour Audible Alarm	Usually assigned to a zone containing an Emergency button (audible emergency).	<ul style="list-style-type: none"> <li>• Follows sounder timeout</li> <li>• Sends a report to the central station, and provides alarm sounds at the keypad.</li> </ul>
24-hour Auxiliary Alarm	Usually assigned to a zone containing a button for use in personal emergencies or to a zone containing monitoring devices (i.e.: water or temperature sensors, etc.).	<ul style="list-style-type: none"> <li>• Sends a report to the central station and provides an alarm sound at the keypad. (There is no keypad timeout.)</li> </ul>
Fire No Verification	Can be assigned to any wireless zone used as a fire zone. This zone type is always active and cannot be bypassed.	<ul style="list-style-type: none"> <li>• Alarm sound will pulse when this zone type is alarmed.</li> </ul>
Interior with Delay	Provides entry delay (using the programmed entry time), if tripped when the panel is armed in the Away mode. Bypassed when the panel is armed in the STAY or STAY INSTANT mode.	<ul style="list-style-type: none"> <li>• Entry delay #1 (with programmed entry time) when armed in the AWAY mode.</li> <li>• Entry delay begins whenever sensors in this zone are violated, regardless of whether an entry/exit delay zone was tripped first.</li> <li>• No entry delay when armed in the AWAY INSTANT mode.</li> <li>• Exit delay regardless of the arming mode selected.</li> </ul>
Monitor	Can be assigned to any wireless zone used for asset protection. Works as a dynamic monitor of a zone fault/trouble (not alarm).	<ul style="list-style-type: none"> <li>• Reports to the central station, if enabled.</li> <li>• Fault/restore events are logged by the system.</li> <li>• Activity Zone No. and Zone Descriptor displayed on LCD.</li> <li>• Restore will be stored in event log.</li> <li>• No keypad sounding or chime</li> <li>• System can still be armed</li> </ul>
24-hour Carbon Monoxide Monitor	Can be assigned to any wireless zone with a carbon monoxide detector. This zone type is always active and cannot be bypassed.	<ul style="list-style-type: none"> <li>• Local keypad and detector will sound when this zone type is alarmed. (Pulse Temporal 4)</li> </ul>

## **Zone Response Type Definitions**

<b>Type</b>	<b>Function</b>	<b>Characteristics</b>
Fire with Verification	Can be assigned to any wireless zone used as a fire zone. Fire with verification is available with smoke detector device type. It can not be used with heat detectors, combination heat/smoke detectors, wireless sensors or fire pull stations. This zone type is always active and cannot be bypassed.	<ul style="list-style-type: none"> <li>• Alarm sound will pulse when this zone type is alarmed. Only after the alarm has been verified.</li> <li>• System verifies alarm by delaying reporting and control panel alarm sounding for 30 seconds after alarm is detected. If the zone remains faulted after 30 seconds a fire alarm is provided. If any other fire zone is faulted during the 30 second delay window a fire alarm is immediately provided for that zone. An alarm for original fire zone will also be provided if that zone is still faulted afterward. If there are no fire alarms after the 30 second delay expires, the system will open a 60 second window. If any fire zone is faulted during that window a fire alarm will immediately be provided for that zone.</li> </ul>
Arm–Stay	Special-purpose zone type used with 5800 Series wireless pushbutton units.	<ul style="list-style-type: none"> <li>• Exit delay regardless of the arming mode selected.</li> <li>• System is armed in the STAY mode when the zone is activated.</li> </ul>
Arm–Away	Special-purpose zone type used with 5800 Series wireless pushbutton units.	<ul style="list-style-type: none"> <li>• System is armed in the AWAY mode when the zone is activated.</li> </ul>
Disarm	Special-purpose zone type used with 5800 Series wireless pushbutton units.	<ul style="list-style-type: none"> <li>• Disarms the system when the zone is activated.</li> </ul>
No Alarm Response	Assigned when no-alarm response is required	<ul style="list-style-type: none"> <li>• No reports to the central station.</li> <li>• No keypad sounding or chime</li> <li>• System can still be armed</li> <li>• No display on the screen</li> </ul>
Silent Burglary	Usually assigned to sensors or contacts on exterior doors and windows where sirens are NOT desired.	<ul style="list-style-type: none"> <li>• Instant alarm, with NO audible indication when is armed in the AWAY, STAY, STAY NO DELAY, or AWAY INSTANT mode.</li> <li>• Report sent to the central station.</li> </ul>
General Monitor	Assigned sensors or contacts on doors and windows or asset protection within the premises. Used to track activity of the occupant and alert occupant of the activity of others.	<ul style="list-style-type: none"> <li>• No reports to the central station.</li> <li>• Fault/restore events are logged by the system.</li> <li>• Monitors entry into a monitored area. Activates a one-time unique chime sound and announcement when faulted.</li> <li>• Activity Zone No. and Zone Descriptor displayed on LCD.</li> </ul>
General Response	Assigned sensors or contacts on doors and windows or asset protection within the premises. Used to track activity of the occupant and alert occupant of the activity of others.	<ul style="list-style-type: none"> <li>• No reports to the central station.</li> <li>• Fault/restore events are logged by the system.</li> <li>• Monitors entry into a monitored area. Activates a unique chime sound and zone announcement when faulted.</li> <li>• Activity Zone No. and Zone Descriptor displayed on LCD.</li> <li>• System re-triggers audible sounding every ten seconds until acknowledged (Off sequence or wireless key button).</li> </ul>
Resident Monitor	Used to monitor a resident in an area deemed to be dangerous by a caregiver.	<ul style="list-style-type: none"> <li>• No reports to the central station.</li> <li>• Monitors entry into a monitored area. Activates a unique chime sound and zone announcement when faulted.</li> <li>• Activity Zone No. and Zone Descriptor displayed on LCD.</li> <li>• If programmed, triggers a voice message (follow me) report.</li> <li>• Fault/Restore events are not logged by the system.</li> </ul>
Resident Response	Used to monitor a resident in an area deemed to be dangerous by a caregiver. Requires acknowledgement by caregiver.	<ul style="list-style-type: none"> <li>• No reports to the central station.</li> <li>• Monitors entry into a monitored area. Activates a unique chime sound and zone announcement when faulted.</li> <li>• Activity Zone No. and Zone Descriptor displayed on LCD.</li> <li>• If programmed, triggers a voice message (follow me) report.</li> <li>• System re-triggers audible sounding every ten seconds until acknowledged (Off sequence or wireless key button).</li> <li>• Fault/Restore events are not logged by the system</li> </ul>
Trouble	Used with Other response type	<ul style="list-style-type: none"> <li>• The system will provide a trouble sounding from the keypad (and a central station report, if desired).</li> </ul>

## Programming the Control

After entering the System Programming mode select from the options provided on the First and Second Installer Programming tools screens as shown in the accompanying figure.

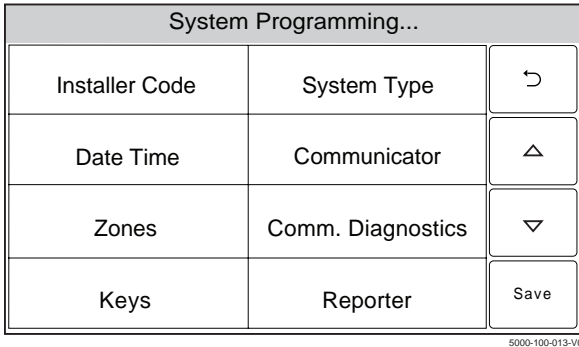

**Page 1**

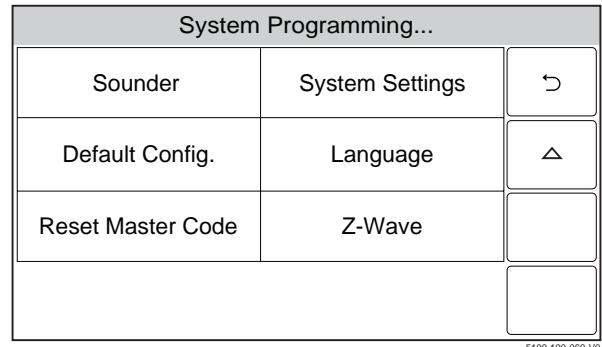

**Page 2**

### Enter Installer Programming Mode without using Installer Code

SCREEN	ACTION
	<ol style="list-style-type: none"> <li>1. During the initial system power-up initialization delay (while "SYSTEM STANDBY!" is displayed), depress the OFF key. Wait for system to terminate the system initialization delay.</li> <li>2. Depress the OFF key again. The touchscreen displays a keypad.</li> <li>3. Press the "Clear" key. A blue vertical bar is displayed below the "Enter Code".</li> <li>4. Enter "00" on the keypad. The system will enter Installer Programming mode and the Installer Tools Menu will be displayed.</li> </ol>

### Change Installer Code

The factory default Installer Code for the LYNX Touch Control is set to 4-1-1-2.

SCREEN	ACTION
	<ol style="list-style-type: none"> <li>1. Select "Installer Code".</li> <li>2. Enter a new four-digit Installer Code on the displayed keypad. The system will display the new code on the left side of the screen.</li> <li>3. Select "Done" when you are finished.</li> <li>4. The system returns to the "System Programming" Screen.</li> </ol>

### Select a Language

**Note:** This programming field may not be available with the system being installed.

SCREEN	ACTION
	<ol style="list-style-type: none"> <li>1. If applicable, select "Language" to display the following options:                      Installer Language   User Language</li> <li>2. Select "Installer Language. The system toggles between "English" and "French".</li> <li>3. Select the desired language.</li> <li>4. Select "User Language. The system toggles between "English" and "French".</li> <li>5. Select the desired language.</li> <li>6. Select "Save" when you are finished.</li> <li>7. A confirmation screen appears. If "Yes" is selected, the System returns to the second page of the Programming screen, which will be displayed in the selected language.</li> </ol>

**Programming the Control**

**System Type**

The following system options are programmed in this section:

Option	Function
RF Jam	Enable or disable RF Jam Log and Reporting
Speaker Phone	Enable or disable Speaker Phone mode. (End User feature)
Two Way Voice	Enable or disable Two Way Voice communication with the Central Station.
RF House Code	Set RF House Code. (Bi-directional RF Devices)
Phone Notification	Enable or disable Phone Notification mode. (Phone Line-cut)
Phone Detect Time	Select a delay period between phone line-cut & system response (allows phone to restore) <b>Note:</b> This field is displayed if Phone Notification is enabled.
Remote Phone	Enable or disable Remote Phone Control mode. (End User feature)
Events	Enable or disable multiple options for event logging (i.e.; alarms, troubles, open/close, bypass, all)
Non-Security	Enable or disable non-security event logging
Remote Access Serial	Enable or disable end user to access their system via a website
Multi Mode Serial	Enable or disable transmission of panel status events via email (Active only when Remote Access Serial is enabled)

**Note:** If applicable, preprogrammed defaults for the LYNX Touch Control are shown on the screen unless otherwise noted.

Screen	ACTION																
<div style="border: 1px solid black; padding: 5px; width: fit-content; margin: 0 auto;"> <p>System Type</p> <p style="font-size: small; margin-top: 5px;">5000-100-130-V0</p> </div>	<p><b>System Type</b> <b>Note:</b> If applicable, the pre-programmed default will be displayed beneath the option.</p> <p>1. Select "System Type" from the following options:</p> <table style="width: 100%; border-collapse: collapse;"> <tr> <td style="width: 50%; text-align: center;">RF Jam</td> <td style="width: 50%; text-align: center;">Speaker Phone</td> </tr> <tr> <td style="text-align: center;">Two Way Voice</td> <td style="text-align: center;">RF House Code</td> </tr> <tr> <td style="text-align: center;">Phone Notification</td> <td style="text-align: center;">Remote Phone</td> </tr> <tr> <td style="text-align: center;">Phone Detect Time</td> <td></td> </tr> </table> <p>Use the down ▼ arrow to scroll to the next page of options.</p> <table style="width: 100%; border-collapse: collapse;"> <tr> <td style="width: 50%; text-align: center;">Events – Log All</td> <td style="width: 50%; text-align: center;">Events – Log Alarm</td> </tr> <tr> <td style="text-align: center;">Events – Log Bypass</td> <td style="text-align: center;">Events – Log Open/Close</td> </tr> <tr> <td style="text-align: center;">Events – Log Trouble</td> <td style="text-align: center;">Non Security</td> </tr> <tr> <td style="text-align: center;">Remote Access Serial</td> <td style="text-align: center;">Multi Mode Serial</td> </tr> </table>	RF Jam	Speaker Phone	Two Way Voice	RF House Code	Phone Notification	Remote Phone	Phone Detect Time		Events – Log All	Events – Log Alarm	Events – Log Bypass	Events – Log Open/Close	Events – Log Trouble	Non Security	Remote Access Serial	Multi Mode Serial
RF Jam	Speaker Phone																
Two Way Voice	RF House Code																
Phone Notification	Remote Phone																
Phone Detect Time																	
Events – Log All	Events – Log Alarm																
Events – Log Bypass	Events – Log Open/Close																
Events – Log Trouble	Non Security																
Remote Access Serial	Multi Mode Serial																
<div style="border: 1px solid black; padding: 5px; width: fit-content; margin: 0 auto;"> <p>RF Jam</p> <p style="text-align: center;"><b>Disabled</b></p> </div>	<p>2. Select "RF Jam". The System scrolls between the following: Disabled RF Jam Log RF Jam Log &amp; Report</p>																
<div style="border: 1px solid black; padding: 5px; width: fit-content; margin: 0 auto;"> <p>Speaker Phone</p> <p style="text-align: center;"><b>Enabled</b></p> </div>	<p>3. Select "Speaker Phone". The System toggles between the following: Disabled Enabled</p>																
<div style="border: 1px solid black; padding: 5px; width: fit-content; margin: 0 auto;"> <p>Two Way Voice</p> <p style="text-align: center;"><b>Disabled</b></p> </div>	<p>4. Select "Two-Way Voice". The System toggles between the following: Disabled Enabled</p>																
<div style="border: 1px solid black; padding: 5px; width: fit-content; margin: 0 auto;"> <p>RF House Code</p> <p style="text-align: center;"><b>0</b></p> </div>	<p>5. Select "RF House Code". 6. After entering a code (00-31) on the displayed keypad, select "Done".</p>																
<div style="border: 1px solid black; padding: 5px; width: fit-content; margin: 0 auto;"> <p>Phone Notification</p> <p style="text-align: center;"><b>Disabled</b></p> </div>	<p>7. Select "Phone Notification" (phone line cut). The System scrolls between the following options: Disabled Keypad Trouble If "Keypad" or "Trouble" is selected proceed to Step 8.</p>																

## **Programming the Control**



<b>Screen</b>	<b>ACTION</b>
<p>Phone Detect Time <b>2 Minutes</b></p>	<p>8. If Keypad or Trouble was selected in Step 7, the "Phone Detect Time" option is displayed. Select "Phone Detect Time". The system scrolls between the following options: 1 Minute 2 Minutes 3 Minutes 4 Minutes</p>
<p>Remote Phone <b>Enabled</b></p>	<p>9. Select "Remote Phone". The System toggles between the following options: Disabled Enabled</p>
<p>Events - Log All <b>Press To Log All</b></p>	<p>Use the down ▼ arrow to scroll to the next page of options. 10. Select "Events - Log All". The system displays "Press To Log All". Selecting this option programs the system to log all events and "Log All Set" is displayed. Additionally all of the options listed below are enabled. Events – Log Alarm Events – Log Bypass Events – Log Open/Close Events – Log Trouble Non-Security <b>OR</b> Proceed to step 11 and select the options individually.</p>
<p>Events – Log Alarm <b>Enabled</b></p>	<p>11. Select "Events – Log Alarm". The System toggles between "Enabled" and "Disabled". 12. Select "Events – Log Bypass". The System toggles between "Enabled" and "Disabled". 13. Select "Events – Log Open/Close". The System toggles between "Enabled" and "Disabled". 14. Select "Events – Log Trouble". The System toggles between "Enabled" and "Disabled".</p>
<p>Remote Access Serial <b>Disabled</b></p>	<p>15. Select "Remote Access Serial". The System toggles between "Enabled" and "Disabled". If the Remote Access Serial" option is enabled, the "Multi Mode Serial" option is displayed.</p>
<p>Non Security <b>Disabled</b></p>	<p>16. Select "Non Security". The System toggles between "Enabled" and "Disabled".</p>
<p>Multi Mode Serial <b>Disabled</b></p>	<p>17. Select "Multi Mode Serial". The System toggles between "Enhanced Reports" and "Disabled". 18. Select "Save" when complete.</p>



**Programming the Control**

**Program Date and Time**

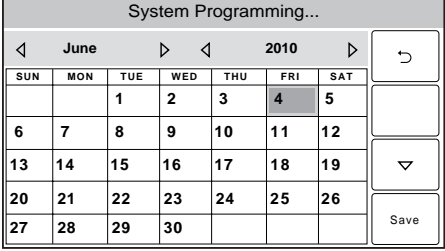
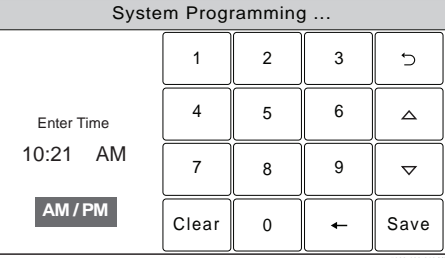
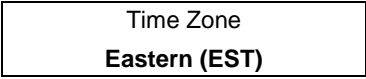
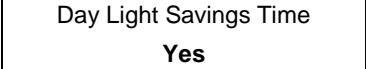
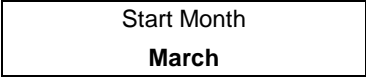
**Note:** If applicable, preprogrammed defaults for the LYNX Touch Control are shown on the screen unless otherwise noted.

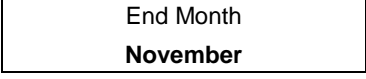
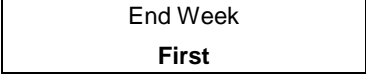
SCREEN	ACTION												
	<p><b>Note:</b> If you are installing a GSMVLP5-4G/GSMVLP5CN4G or ILP5 Communication Module, the time and date will be programmed and updated automatically via Central Station. You must still program the correct Time Zone below.</p> <ol style="list-style-type: none"> <li>1. Select "Date Time".</li> </ol>												
	<ol style="list-style-type: none"> <li>2. Using the left ◀ and right ▶ arrows select the Month and Year then select the date. Select the ▼ key to advance to the next screen.</li> </ol>												
	<ol style="list-style-type: none"> <li>3. To set the correct time, touch the "Clear" button.</li> <li>4. Enter the correct time and then select AM or PM. Select the ▼ key to advance to the next screen or select "Save" to return to the System Programming Screen.</li> </ol>												
	<ol style="list-style-type: none"> <li>6. Select "Time Zone". The system scrolls between the following options:  <table border="0" style="width: 100%;"> <tr> <td>Eastern (EST)</td> <td>Mountain (MST)</td> <td>Atlantic (AST)</td> </tr> <tr> <td>Central (CST)</td> <td>Pacific (PST)</td> <td>Newfoundland (NT)</td> </tr> <tr> <td>Hawaii (HAST)</td> <td>Alaska (AKST)</td> <td></td> </tr> </table> </li> </ol>	Eastern (EST)	Mountain (MST)	Atlantic (AST)	Central (CST)	Pacific (PST)	Newfoundland (NT)	Hawaii (HAST)	Alaska (AKST)				
Eastern (EST)	Mountain (MST)	Atlantic (AST)											
Central (CST)	Pacific (PST)	Newfoundland (NT)											
Hawaii (HAST)	Alaska (AKST)												
	<ol style="list-style-type: none"> <li>6. Select "Day Light Savings Time". The system toggles between "Yes" and "No". If "Yes" is selected the following options will become active.</li> </ol>												
	<ol style="list-style-type: none"> <li>7. Select "Start Month". The system displays the following options.  <table border="0" style="width: 100%;"> <tr> <td>January</td> <td>February</td> </tr> <tr> <td>March</td> <td>April</td> </tr> <tr> <td>May</td> <td>June</td> </tr> <tr> <td>July</td> <td>August</td> </tr> </table>                     Use the down ▼ arrow to scroll to the next page of options.  <table border="0" style="width: 100%;"> <tr> <td>September</td> <td>October</td> </tr> <tr> <td>November</td> <td>December</td> </tr> </table> </li> </ol>	January	February	March	April	May	June	July	August	September	October	November	December
January	February												
March	April												
May	June												
July	August												
September	October												
November	December												
	<ol style="list-style-type: none"> <li>8. Select "Start Week". The system scrolls between the following options.  <table border="0" style="width: 100%;"> <tr> <td>First</td> <td>Fourth</td> <td>3rd from Last</td> </tr> <tr> <td>Second</td> <td>Last</td> <td></td> </tr> <tr> <td>Third</td> <td>Next to Last</td> <td></td> </tr> </table> </li> </ol>	First	Fourth	3rd from Last	Second	Last		Third	Next to Last				
First	Fourth	3rd from Last											
Second	Last												
Third	Next to Last												
	<ol style="list-style-type: none"> <li>9. Select "End Month". The system displays the following options.  <table border="0" style="width: 100%;"> <tr> <td>January</td> <td>February</td> </tr> <tr> <td>March</td> <td>April</td> </tr> <tr> <td>May</td> <td>June</td> </tr> <tr> <td>July</td> <td>August</td> </tr> </table>                     Use the down ▼ arrow to scroll to the next page of options.  <table border="0" style="width: 100%;"> <tr> <td>September</td> <td>October</td> </tr> <tr> <td>November</td> <td>December</td> </tr> </table> </li> </ol>	January	February	March	April	May	June	July	August	September	October	November	December
January	February												
March	April												
May	June												
July	August												
September	October												
November	December												
	<ol style="list-style-type: none"> <li>10. Select "End Week". The system will scrolls through the available weeks.  <table border="0" style="width: 100%;"> <tr> <td>First</td> <td>Fourth</td> <td>3rd from Last</td> </tr> <tr> <td>Second</td> <td>Last</td> <td></td> </tr> <tr> <td>Third</td> <td>Next to Last</td> <td></td> </tr> </table> </li> <li>11. After programming these options, select the "Save" key.</li> </ol>	First	Fourth	3rd from Last	Second	Last		Third	Next to Last				
First	Fourth	3rd from Last											
Second	Last												
Third	Next to Last												

## Programming the Control

### Program the Communications Module



**A router is required if you are installing the L5100-WiFi module. The router must be powered on and connected for WiFi operation (alarm reporting) to occur.**

The following system options are programmed in this section:

Option	Function
Communications Path	Selects type of Communications Module
APL	Enables Advanced Protection Logic
City ID	Enter Central Station Primary City ID
CS ID	Enter Primary Central Station ID
Sub ID	Enter Central Station Primary Subscriber ID
Supervision	Selects how often the Communications Module sends supervisory messages to the Central Sta.
Old Alarm Time	Selects how long an undeliverable alarm delivery is retried to the Central Station.
Remote Acc. Comm.	Enables or disables user remote access via internet and/or GSM.
Multi Mode Comm.	(appears only if Remote Access IP or GSM is enabled.) Enables or disables multi mode feature.
IP Fault Time	(Appears only if IP is enabled in Communications Path field.) Selects time delay before the Communications Module notifies the control panel of a loss of contact with the internet.
Use DHCP	Dynamically selects the IP addresses
NIC IP Address	(Appears only if "No" is selected in Use DHCP field.) Enter NIC IP Address.
Subnet Mask	(Appears only if "No" is selected in Use DHCP field.) Enter Subnet Address.
Gateway IP Address	(Appears only if "No" is selected in Use DHCP field.) Enter Gateway IP Address
DNS Server IP Address	(Appears only if "No" is selected in Use DHCP field.) Enter Domain Name Server IP Address.
GSM Fault Time	(Appears only if GSM is enabled in Communications Path field.) Selects time delay before the Communications Module notifies the control panel of a loss of contact with the network.
GSM Rollover	Allows messages to be sent over GSM in the event that contact with the internet is lost. (Appears only if "WiFi & GSM" is selected as the Communications Path.)
GSM 24 Hour Test	Enables daily test of GSM module operation. (Appears only if "WiFi & GSM" is selected as the Communications Path.)

**Note:** If applicable, preprogrammed defaults for the LYNX Touch Control are shown on the screen unless otherwise noted.



Remote Access (Total Connect) and Multi Mode (PSD) over IP or GSM cannot be enabled in the panel alone. Availability of this service is controlled via the web-based programming tool on the AlarmNet Direct website. These features must be enabled through the AlarmNet Direct website first and transferred to the device.

SCREEN	ACTION												
<div style="border: 1px solid black; padding: 5px; text-align: center;"> <b>Communicator</b>   <small>5000-100-132-VO</small> </div>	<p><b>Communicator</b></p> <ol style="list-style-type: none"> <li>Select "Communicator". The System displays several pages of options that vary depending upon the selections that are made. Use the down ▼ arrow to scroll through the pages of options.                     <table style="margin-left: 40px; border-collapse: collapse;"> <tr> <td style="border-right: 1px solid black; padding: 5px;">Communications Path</td> <td style="padding: 5px;">APL</td> </tr> <tr> <td style="border-right: 1px solid black; padding: 5px;">City ID</td> <td style="padding: 5px;">Sub ID</td> </tr> <tr> <td style="border-right: 1px solid black; padding: 5px;">Supervision</td> <td style="padding: 5px;">Old Alarm Time</td> </tr> <tr> <td style="border-right: 1px solid black; padding: 5px;">Remote Acc. Comm.</td> <td style="padding: 5px;">Multi Mode Comm.</td> </tr> <tr> <td style="border-right: 1px solid black; padding: 5px;">IP Fault Time</td> <td style="padding: 5px;">Use DHCP</td> </tr> <tr> <td style="border-right: 1px solid black; padding: 5px;">GSM Fault Time</td> <td></td> </tr> </table> </li> </ol>	Communications Path	APL	City ID	Sub ID	Supervision	Old Alarm Time	Remote Acc. Comm.	Multi Mode Comm.	IP Fault Time	Use DHCP	GSM Fault Time	
Communications Path	APL												
City ID	Sub ID												
Supervision	Old Alarm Time												
Remote Acc. Comm.	Multi Mode Comm.												
IP Fault Time	Use DHCP												
GSM Fault Time													
<div style="border: 1px solid black; padding: 5px; text-align: center;">                     Communications Path  <b>None</b> </div>	<ol style="list-style-type: none"> <li>Select "Communications Path". The system scrolls between the following options dependant upon which communications module(s) are installed:                      None                      IP                      GSM                      WiFi                      WiFi &amp; GSM                 </li> </ol>												
<div style="border: 1px solid black; padding: 5px; text-align: center;">                     APL  <b>Disabled</b> </div>	<ol style="list-style-type: none"> <li>Select "APL". The system scrolls between "Enabled" and "Disabled".  <b>Note:</b> If APL is used, GSM or IP must be selected as the Primary Communicator Type in the Reporter programming.                 </li> </ol>												
<div style="border: 1px solid black; padding: 5px; text-align: center;">                     City ID                 </div>	<ol style="list-style-type: none"> <li>Select "City ID". Enter the 2-digit Primary City ID (Decimal).  <b>Options</b>                      01-99                 </li> </ol>												
<div style="border: 1px solid black; padding: 5px; text-align: center;">                     CS ID                 </div>	<ol style="list-style-type: none"> <li>Select "CS ID". Enter the 2-digit Primary Central Station ID (HEX).  <b>Options</b>                      01-FE                 </li> </ol>												

**Programming the Control**

SCREEN	ACTION										
<p style="text-align: center;">Sub ID</p>	<p>6. Select "Sub ID". Enter the 4-digit Subscriber Account Number (Decimal).  <b>Options</b>                      0001-9999</p>										
<p style="text-align: center;">Supervision 24 Hours</p>	<p>7. Select "Supervision". The system scrolls between the following options:                      24 Hours                      None                      30 Days</p>										
<p style="text-align: center;">Old Alarm Time 10 Minutes</p>	<p>8. Select "Old Alarm Time". The system scrolls between the following options. Use the down ▼ arrow to scroll to the next page of options.</p> <table border="0" style="width: 100%;"> <tr> <td style="width: 50%;">10 Minutes</td> <td style="width: 50%;">15 Minutes</td> </tr> <tr> <td>30 Minutes</td> <td>1 Hour</td> </tr> <tr> <td>2 Hours</td> <td>4 Hours</td> </tr> <tr> <td>8 Hours</td> <td>12 Hours</td> </tr> <tr> <td>24 Hours</td> <td></td> </tr> </table>	10 Minutes	15 Minutes	30 Minutes	1 Hour	2 Hours	4 Hours	8 Hours	12 Hours	24 Hours	
10 Minutes	15 Minutes										
30 Minutes	1 Hour										
2 Hours	4 Hours										
8 Hours	12 Hours										
24 Hours											
<p style="text-align: center;">Remote Acc. Comm. Disabled</p>	<p>9. Select "Remote Acc. Comm.". The system toggles between "Disabled" and "Enabled".  <b>Note:</b> This field will not be programmable unless it is enabled when creating the Communications Module account in AlarmNet.</p>										
<p style="text-align: center;">Multi Mode Comm. Disabled</p>	<p>10. If "Remote Access Comm." was enabled in the previous step, the "Multi Mode Comm." option is displayed. The system scrolls between the following options.                      Disabled                      Relay Reports                      Enhanced Reports  <b>Note:</b> This field will not be programmable unless it is enabled when creating the Communications Module account in AlarmNet. The Relay Reports option should not be selected when using TotalConnect 2.1 Service.</p> <p>11. Use the down ▼ arrow to scroll to the next page of options. If IP was selected in step 2, proceed to step 12. If GSM was selected in step 2, proceed to step 19.</p>										
<p style="text-align: center;">IP Fault Time (min) 00</p>	<p>12. Select "IP Fault Time (min)". Enter the time delay (in minutes) on the keypad.  <b>Options</b>                      00-99</p>										
<p style="text-align: center;">Use DHCP Yes</p>	<p>13. Select "Use DHCP". The system toggles between "Yes" and "No". If "No" is selected the system displays four additional options. If "Yes" is selected, skip to step 18.</p>										
<p style="text-align: center;">NIC IP Address 255.255.255.255</p>	<p>14. Select "NIC IP Address". Enter the 4-part address on the displayed keypad.</p>										
<p style="text-align: center;">Subnet Mask 255.255.255.255</p>	<p>15. Select "Subnet Mask". Enter the 4-part address on the displayed keypad.</p>										
<p style="text-align: center;">Gateway IP Address 255.255.255.255</p>	<p>16. Select "Gateway IP Address". Enter the 4-part address on the displayed keypad.</p>										
<p style="text-align: center;">DNS Server IP Address 255.255.255.255</p>	<p>17. Select "DNS Server IP Address". Enter the 4-part address on the displayed keypad.                      18. If "IP" was selected in step 2, select "Save" and then select "OK" when the "Programming Done" screen appears. Proceed to "Diagnostics" section in order to register the device.</p>										
<p style="text-align: center;">GSM Fault Time (min) 00</p>	<p>19. Select "GSM Fault Time (min)". Enter the time delay (in minutes) on the keypad.  <b>Options</b>                      00-99</p>										
<p style="text-align: center;">GSM Rollover No</p>	<p>20. If "WiFi and GSM" was selected in step 2, two additional programming fields are displayed. Select "GSM Rollover", the system toggles between "Yes" and "No".</p>										
<p style="text-align: center;">GSM 24 Hour Test No</p>	<p>19. Select "GSM 24 Hour Test", the system toggles between "Yes" and "No".                      20. If "GSM" was selected in step 2, select "Save" and then select "OK" when the "Programming Done" screen appears. Proceed to "Diagnostics" section in order to register the device.</p>										

## **Programming the Control**

### **Program the Z-Wave Module**

The following system options are programmed in this section:

<b>Option</b>	<b>Function</b>
Z-Wave	Enables or disables the Z-Wave Module
Temperature Display	Toggles between Fahrenheit and Celsius (for Z-Wave Theromstat)

- Notes:**
1. This programming field will only be visible if a Z-Wave Module is installed in the control.
  2. If applicable, preprogrammed defaults for the LYNX Touch Control are shown on the screen unless otherwise noted.
  3. The Z-Wave option must be enabled before installing the Z-Wave Module in the LYNX Touch Control.
  4. In the event that the Z-Wave option has been changed to “Disabled” and then enabled, the LYNX Touch power must be recycled or the system must be rebooted. Refer to the *Rebooting the System* section for additional information.

<b>SCREEN</b>	<b>ACTION</b>
<div style="border: 1px solid black; padding: 10px; width: fit-content; margin: auto;"> <p>Z - Wave</p> <p style="font-size: small; margin-top: 5px;">5100-100-067-V0</p> </div>	<p><b>Note:</b> This procedure must be completed any time that the panel has been defaulted or updated.</p> <ol style="list-style-type: none"> <li>1. Enter Program Mode and default the panel (Refer to “Loading Factory Defaults”).</li> <li>2. Select “Z-Wave” The System displays the following options:  <div style="text-align: center;">                     Z-Wave                      Temperature Display                 </div> </li> </ol>
<div style="border: 1px solid black; padding: 5px; width: fit-content; margin: auto;"> <p>Z-Wave Enabled-Installed Telephone</p> </div>	<ol style="list-style-type: none"> <li>3. Select “Z-Wave”. The system scrolls between the following options:                      Enabled – Installed Telephone Side                      Disabled                      Select “Enabled – Installed Telephone Side”.                 </li> </ol>
<div style="border: 1px solid black; padding: 5px; width: fit-content; margin: auto;"> <p>Temperature Display Fahrenheit</p> </div>	<ol style="list-style-type: none"> <li>4. If you wish to change the temperature format, select “Temperature Display”. The system scrolls between the following options:                      Fahrenheit                      Celsius                 </li> <li>5. Select “Save”.</li> <li>6. Exit Programming mode.</li> <li>7. Remove AC power and disconnect battery.</li> <li>8. Install Z-Wave module.</li> <li>9. Connect battery and apply AC power.</li> <li>10. At the Security Home screen Select “Automation”.</li> <li>11. At the next screen Select “Tools”.</li> <li>12. At the next screen Select “Advanced Tools”.</li> <li>13. Enter the Master User Code “1-2-3-4” on the displayed keypad.</li> <li>14. At the next screen select “Reset Controller”.</li> <li>15. The system displays “Done”. Select OK.</li> <li>16. Select the “↶” key to return to the previous screen.</li> <li>17. Include Z-Wave devices. (Refer to Including/Excluding Z-Wave Devices in the Home Automation Guide P/N 800-11309 or higher.)</li> </ol>

**Programming the Control**

**Program Zones**

The following system options are programmed in this section:

Option	Function
Serial Number	Manually enter device serial number or enroll via RF transmission
Loop Number	Manually enter device loop number or enroll via RF transmission
Zone Description 1/2	Enter Zone Descriptors for the device being enrolled
Device Type	Select the type of device being enrolled
Response Type	Select the alarm response for the device being enrolled (refer to Zone Response Type Table)
Alarm Report	Activate reporting option for the device being enrolled
Chime	Enable/disable chime mode for specific device being enrolled (applies to Entry/ Exit, Perimeter, and Interior Response types only)
Supervision	Select supervision for device being enrolled

**Note:** If applicable, preprogrammed defaults for the LYNX Touch Control are shown on the screen unless otherwise noted.

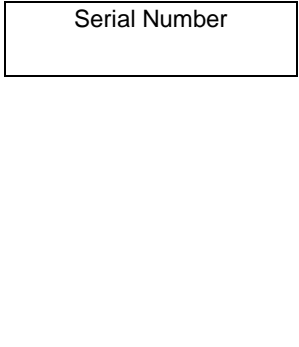
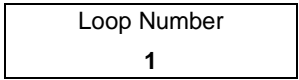
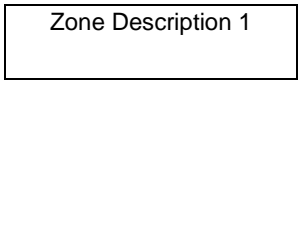
SCREEN	ACTION																		
	<p>1. Select "Zones" The System displays the following options:</p> <table border="0"> <tr> <td>1. New</td> <td>2. Front Door</td> </tr> <tr> <td>3. Back Door</td> <td>4. Window</td> </tr> <tr> <td>5. Motion Sensor</td> <td>6. New</td> </tr> </table> <p>2. Use the down ▼ arrow to scroll to the next page of options. Use the ▲ arrow to return to the previous page.</p> <p>7. – 48. New 49. – 56. 4 Button 57. – 64. New 80. – 85. Temperature (Z-Wave Thermostat zones) 95. Fire 96. Medical 99. Police</p> <p>3. Select a zone and then select "Edit" or "Add New" to program the next available zone. The following options are displayed (dependant upon Zone Type):</p> <table border="0"> <tr> <td>Serial Number *</td> <td>Loop Number *</td> <td>* This field does not apply to Hardwire Zone 1 or Temperature Zones 80-85.</td> </tr> <tr> <td>Zone Description 1</td> <td>Zone Description 2</td> <td></td> </tr> <tr> <td>Device Type</td> <td>Response Type</td> <td></td> </tr> <tr> <td>Alarm Report</td> <td>Chime</td> <td>Supervision</td> </tr> </table> <p>4. Select an option to display the next programming field.</p>	1. New	2. Front Door	3. Back Door	4. Window	5. Motion Sensor	6. New	Serial Number *	Loop Number *	* This field does not apply to Hardwire Zone 1 or Temperature Zones 80-85.	Zone Description 1	Zone Description 2		Device Type	Response Type		Alarm Report	Chime	Supervision
1. New	2. Front Door																		
3. Back Door	4. Window																		
5. Motion Sensor	6. New																		
Serial Number *	Loop Number *	* This field does not apply to Hardwire Zone 1 or Temperature Zones 80-85.																	
Zone Description 1	Zone Description 2																		
Device Type	Response Type																		
Alarm Report	Chime	Supervision																	
	<p><b>Serial Number</b> (This field does not apply to Temperature Zones 80-85) When "Serial Number" has been selected "Enter Serial Number or Activate" is displayed. The transmitter serial number and loop number can be enrolled via RF transmission OR manually.</p> <p><b>Enroll via RF Learning</b> To enroll the device using RF Learning mode three transmissions (open/close) of the device will be required. The initial transmission activates the RF Learning mode and the system will emit a single beep. A second transmission enrolls the serial number and the system beeps two times and displays "Activate Sensor Again To Confirm". A third transmission will confirm the serial number. The system beeps two times and returns to the Zone programming Screen.</p> <p><b>Enroll Manually</b> Enter the 7-digit serial number printed on the transmitter using the displayed keypad and select "Done". The system beeps one time and returns to the Zone programming Screen.</p>																		
	<p><b>Loop Number</b> (This field does not apply to Temperature Zones 80-85) Select "Loop Number" to toggle between 1, 2, 3 and 4. Enter Save.</p>																		
	<p><b>Zone Description 1/Zone Description 2</b> When programming the Zone Description, after entering the first letter of the description on the keypad you can use the up ▲ and down ▼ arrows to scroll through the available preprogrammed zone descriptions. For a list of the pre-programmed Zone Descriptors, please visit <a href="http://www.security.honeywell.com/hsc/resources/MyWebTech">http://www.security.honeywell.com/hsc/resources/MyWebTech</a></p> <p>Select "Zone Description 1 or Zone Description 2". Using the displayed keypad enter Zone Description 1 or Zone Description 2. The system announces the Zone Description. Enter "Done", when you are finished. The system returns to the Zone Programming page.</p>																		

**Programming the Control**

SCREEN	ACTION																										
<p>Device Type</p>	<p><b>Device Type</b>                      Select "Device Type". The system displays the following options (dependant upon the Device Type selection):</p> <table border="0"> <tr> <td>New</td> <td>Door</td> </tr> <tr> <td>Window</td> <td>Motion Sensor</td> </tr> <tr> <td>Glass Break</td> <td>Smoke Detector</td> </tr> <tr> <td>Heat Sensor</td> <td>Carbon Mono. Det.</td> </tr> </table> <p>Use the down ▼ arrow to scroll to the next page of options:</p> <table border="0"> <tr> <td>Temperature</td> <td>Flood</td> </tr> <tr> <td>Environmental</td> <td>Medical</td> </tr> <tr> <td>Fire</td> <td>Police</td> </tr> <tr> <td>Other</td> <td></td> </tr> </table>	New	Door	Window	Motion Sensor	Glass Break	Smoke Detector	Heat Sensor	Carbon Mono. Det.	Temperature	Flood	Environmental	Medical	Fire	Police	Other											
New	Door																										
Window	Motion Sensor																										
Glass Break	Smoke Detector																										
Heat Sensor	Carbon Mono. Det.																										
Temperature	Flood																										
Environmental	Medical																										
Fire	Police																										
Other																											
<p>Response Type</p> <p><b>Not Used</b></p>	<p><b>Response Type</b></p> <p>1. Select "Response Type". The system displays the specific options, which are dependant upon the Device Type that was selected for the zone. Use the down ▼ arrow to scroll to the next page of options. Use the ▲ arrow to return to the previous page.</p> <table border="0"> <tr> <td>Not Used</td> <td>Entry Exit 1</td> </tr> <tr> <td>Entry Exit 2</td> <td>Perimeter</td> </tr> <tr> <td>Interior Follower</td> <td>Trouble Alarm</td> </tr> <tr> <td>24 Hour Silent</td> <td>24 Hour Audible</td> </tr> <tr> <td>24 Hour Auxiliary</td> <td>Fire No Verification</td> </tr> <tr> <td>Interior With Delay</td> <td>Monitor</td> </tr> <tr> <td>Carbon Monoxide</td> <td>Trouble</td> </tr> <tr> <td>Arm Stay</td> <td>Arm Away</td> </tr> <tr> <td>Disarm</td> <td>No Response</td> </tr> <tr> <td>Silent Burglary</td> <td>Resident Monitor</td> </tr> <tr> <td>Resident Response</td> <td>General Monitor</td> </tr> <tr> <td>General Response</td> <td>Fire With Verification</td> </tr> <tr> <td>Day/Night</td> <td></td> </tr> </table> <p>2. Select the desired Response Type and select "Save". The system will return to the Zone screen.</p> <p><b>Note:</b> For threshold monitoring to be configurable on the LYNX TOUCH Z-wave thermostat screen, the respective zones will first need to be assigned with a response type in zone programming. The recommended response type is Trouble.</p>	Not Used	Entry Exit 1	Entry Exit 2	Perimeter	Interior Follower	Trouble Alarm	24 Hour Silent	24 Hour Audible	24 Hour Auxiliary	Fire No Verification	Interior With Delay	Monitor	Carbon Monoxide	Trouble	Arm Stay	Arm Away	Disarm	No Response	Silent Burglary	Resident Monitor	Resident Response	General Monitor	General Response	Fire With Verification	Day/Night	
Not Used	Entry Exit 1																										
Entry Exit 2	Perimeter																										
Interior Follower	Trouble Alarm																										
24 Hour Silent	24 Hour Audible																										
24 Hour Auxiliary	Fire No Verification																										
Interior With Delay	Monitor																										
Carbon Monoxide	Trouble																										
Arm Stay	Arm Away																										
Disarm	No Response																										
Silent Burglary	Resident Monitor																										
Resident Response	General Monitor																										
General Response	Fire With Verification																										
Day/Night																											
<p>Alarm Report</p> <p><b>Yes</b></p>	<p><b>Alarm Report</b></p> <p><b>Note:</b> This field is for Alarms. If Response Type "Trouble" is set up and Alarm Report is set to "No" the system will still report if Report Alarms was enabled in the Reporter programming.</p> <p>Select "Report" to toggle between "No" or "Yes". Select "Save".</p>																										
<p>Chime</p> <p><b>No</b></p>	<p><b>Chime</b></p> <p><b>Note:</b> Chime only applies to entry/exit, perimeter and interior zone types.</p> <p>Select "Chime" to toggle between "No" or "Yes". Select "Save".</p>																										
<p>Supervision</p> <p><b>Supervised</b></p>	<p><b>Supervision</b></p> <p>The system displays the applicable Supervision options based upon the Device Type that was selected. Select "Supervision" to scroll between the following options:</p> <p><b>Hardwire Zone</b></p> <p>Normal Open                      Normal Closed                      End of Line</p> <p><b>RF Zone</b></p> <p>Supervised                      Unsupervised</p> <p><b>Temperature</b> (Defaulted for Zones 80-85)                      High Temp (Default selection for Zones 80, 82 and 84)                      Low Temp (Default selection for Zones 81, 83 and 85)</p> <p>After making a Supervision selection, select "Save".</p>																										

## Programming the Control Program Keys

The following system options are programmed in this section

Option	Function
Key Type	Select the specific type of key being entered or enrolled
User	Associates the Key with a specific User
Serial Number	Manually enter key serial number or enroll via RF transmission
Zone	Manually enter key zone number (between 49 and 64) or enroll via RF transmission
Button Key * - Zn *	Associate the selected button with a specific function

\* Key number and Zn number are dependant upon the Key Type selected.

**Note:** If applicable, preprogrammed defaults for the LYNX Touch Control are shown on the screen unless otherwise noted.

SCREEN	ACTION																							
<b>Keys</b>	<ol style="list-style-type: none"> <li>Select "Keys" The System displays the following options:  <table style="margin-left: 40px; border-collapse: collapse;"> <tr> <td style="padding: 0 10px;">Edit</td> <td style="padding: 0 10px;"> </td> <td style="padding: 0 10px;">Add New</td> <td style="padding: 0 10px;"> </td> <td style="padding: 0 10px;">Delete</td> </tr> </table> </li> <li>Select "Add New".</li> <li>The following options are displayed (dependant upon the "Key Type" selected):  <table style="margin-left: 40px; border-collapse: collapse;"> <tr> <td style="padding: 0 10px;">Key Type</td> <td style="padding: 0 10px;"> </td> <td style="padding: 0 10px;">User</td> </tr> <tr> <td style="padding: 0 10px;">Serial Number</td> <td style="padding: 0 10px;"> </td> <td style="padding: 0 10px;">Zone</td> </tr> <tr> <td style="padding: 0 10px;">Button Key 1 – Zn 49</td> <td style="padding: 0 10px;"> </td> <td style="padding: 0 10px;">Button Key 2 – Zn 50</td> </tr> <tr> <td style="padding: 0 10px;">Button Key 3 – Zn 51</td> <td style="padding: 0 10px;"> </td> <td style="padding: 0 10px;">Button Key 4 – Zn 52</td> </tr> <tr> <td style="padding: 0 10px;">Button Key 5 – Zn 53</td> <td style="padding: 0 10px;"> </td> <td style="padding: 0 10px;">Button Key 6 – Zn 54</td> </tr> <tr> <td style="padding: 0 10px;">Button Key 7 – Zn 55</td> <td style="padding: 0 10px;"> </td> <td style="padding: 0 10px;">Button Key 8 – Zn 56</td> </tr> </table> </li> <li>Select an option to display the next programming field.</li> </ol>	Edit		Add New		Delete	Key Type		User	Serial Number		Zone	Button Key 1 – Zn 49		Button Key 2 – Zn 50	Button Key 3 – Zn 51		Button Key 4 – Zn 52	Button Key 5 – Zn 53		Button Key 6 – Zn 54	Button Key 7 – Zn 55		Button Key 8 – Zn 56
Edit		Add New		Delete																				
Key Type		User																						
Serial Number		Zone																						
Button Key 1 – Zn 49		Button Key 2 – Zn 50																						
Button Key 3 – Zn 51		Button Key 4 – Zn 52																						
Button Key 5 – Zn 53		Button Key 6 – Zn 54																						
Button Key 7 – Zn 55		Button Key 8 – Zn 56																						
Key Type <b>4 Button key</b>	<p><b>Key Type</b> Select "Key Type". The system scrolls between the following:</p> <table style="margin-left: 40px; border-collapse: collapse;"> <tr> <td style="padding: 0 10px;">1 Button key</td> <td style="padding: 0 10px;"> </td> <td style="padding: 0 10px;">6 Button key</td> </tr> <tr> <td style="padding: 0 10px;">2 Button key</td> <td style="padding: 0 10px;"> </td> <td style="padding: 0 10px;">8 Button key</td> </tr> <tr> <td style="padding: 0 10px;">4 Button key</td> <td></td> <td></td> </tr> </table>	1 Button key		6 Button key	2 Button key		8 Button key	4 Button key																
1 Button key		6 Button key																						
2 Button key		8 Button key																						
4 Button key																								
User	<p><b>User</b></p> <ol style="list-style-type: none"> <li>Select "User" then select from the following options (or the list of Users that have been programmed):  <table style="margin-left: 40px; border-collapse: collapse;"> <tr> <td style="padding: 0 10px;">Master</td> <td style="padding: 0 10px;"> </td> <td style="padding: 0 10px;">Babysitter</td> </tr> <tr> <td style="padding: 0 10px;">Duress</td> <td style="padding: 0 10px;"> </td> <td style="padding: 0 10px;">User 3</td> </tr> <tr> <td style="padding: 0 10px;">User 4</td> <td style="padding: 0 10px;"> </td> <td style="padding: 0 10px;">User 5</td> </tr> <tr> <td style="padding: 0 10px;">User 6</td> <td style="padding: 0 10px;"> </td> <td style="padding: 0 10px;">User 7</td> </tr> </table> </li> </ol> <p>Use the down ▼ arrow to scroll to the next page. The system displays options for User 8 through 14.</p> <p><b>Note:</b> The Key must be associated with a specific User/User Code in order for it to operate. Refer to the LYNX Touch User Guide for additional Information regarding User Codes.</p>	Master		Babysitter	Duress		User 3	User 4		User 5	User 6		User 7											
Master		Babysitter																						
Duress		User 3																						
User 4		User 5																						
User 6		User 7																						
Serial Number <b>0</b>	<p><b>Serial Number</b> When "Serial Number" has been selected "Enter Serial Number or Activate" is displayed. The transmitter serial number and loop number can be enrolled via RF transmission OR manually.</p> <p><b>Enroll via RF Learning</b> To enroll the device using RF Learning mode three transmissions (open/close) of the device will be required. The initial transmission activates the RF Learning mode. A second transmission enrolls the serial number and the system beeps two times and displays "Activate Sensor Again To Confirm". A third transmission will confirm the serial number. The system beeps three times and returns to the Zone programming Screen.</p> <p><b>Enroll Manually</b> Enter the 7-digit serial number printed on the transmitter using the displayed keypad and select "Done". The system beeps one time and returns to the Zone programming Screen.</p>																							
Zone <b>49</b>	<p><b>Zone</b> The system displays the next available key Zone number. Select "Zone" to manually enter a specific Zone Number on the displayed keypad (49-64). If the desired Zone Number is not available, the system returns to the previous screen.</p> <p>Select "Done". The system returns to the previous screen. Repeat the previous step to enter another Zone Number.</p>																							

## **Programming the Control**

SCREEN	ACTION										
<p>Button Key * - Zn *</p>	<p><b>Button Key * Zn *</b>                      Select the desired Button Key and enter a function for each button key. The system displays the following options:</p> <table border="0"> <tr> <td>Disarm</td> <td>Arm Away</td> </tr> <tr> <td>Arm Stay</td> <td>No Response</td> </tr> <tr> <td>24 Hour Silent</td> <td>24 Hour Audible</td> </tr> <tr> <td>24 Hour Auxiliary</td> <td>Silent Burglary</td> </tr> <tr> <td>Fire No Verification</td> <td></td> </tr> </table> <p>* Options are the same for each Button/Zone combination.</p>	Disarm	Arm Away	Arm Stay	No Response	24 Hour Silent	24 Hour Audible	24 Hour Auxiliary	Silent Burglary	Fire No Verification	
Disarm	Arm Away										
Arm Stay	No Response										
24 Hour Silent	24 Hour Audible										
24 Hour Auxiliary	Silent Burglary										
Fire No Verification											



## Programming the Control Reporter



When Compass service is required and GSM or IP are the only reporting channels: As part of Primary Central Station programming; the "Phone Type" must be set to any selection other than "None", the "Communicator Type" must be set to GSM or IP, as applicable, and must match the compass value; "Phone number" field must be left blank and an "Account number" must be programmed.

The following system options are programmed in this section:

Option	Function
<b>Primary or Secondary CS Info</b>	Enroll information pertaining to the Primary and/or Secondary Central Station.
Phone Type	Select the Report Format that will be used to send reports to the Primary or Secondary Central Station, as applicable.
Phone Number	Enter the Phone Number for the Primary or Secondary Central Station, as applicable.
Communicator Type	Select the type of Communications Module that will be used to communicate with the Primary or Secondary Central Station, as applicable.
Account Number	Enter the account number for the Primary or Secondary Central Station, as applicable.
Dynamic Priority	Select the primary method for sending Reports to the Primary or Secondary Central Station, as applicable.
Dynamic Delay	Selects delay between switching between reporting methods. Active if Dynamic Delay feature has been set to Preferred Telco or Preferred Radio.
Report All	Enable All Reports to be sent to the Primary or Secondary Central Station, as applicable.
Report Alarms	Enable Alarm Reporting to the Primary or Secondary Central Station, as applicable.
Report Troubles	Enable Trouble Reporting to the Primary or Secondary Central Station, as applicable.
Report Open/Close	Enable Open/Close Reporting to the Primary or Secondary Central Station, as applicable.
Report Tests	Enable Test Reporting to the Primary or Secondary Central Station, as applicable.
<b>Follow Me Phone 1 or Phone 2</b>	Enroll information Primary and/or Secondary telephone numbers for "Follow Me" Announcements and/or Reminders.
Phone Type	Enter Number for Follow Me Phone 1 or Phone 2, as applicable.
Phone Number	Enter Primary and/or Secondary telephone numbers for "Follow Me" Announcements and/or Reminders.
Report All	Enable All Reports to be sent to the Follow Me Phone 1 or Phone 2, as applicable.
Report Alarms	Enable Alarm Reporting to the Follow Me Phone 1 or Phone 2, as applicable.
Report Troubles	Enable Trouble Reporting to the Follow Me Phone 1 or Phone 2, as applicable.
Report Open/Close	Enable Open/Close Reporting to the Follow Me Phone 1 or Phone 2, as applicable.
Report Tests	Enable Test Reporting to the Follow Me Phone 1 or Phone 2, as applicable.
<b>Report Selection</b>	Enable Reporting of Specific Events
<b>Options</b>	
PBX	Enter the digits required to access an outside line, if applicable
Call Wait Cancel	Enter the digits required to cancel call waiting, if applicable
Number of Reports	Limit the number of messages sent to the Central Station during an armed period. (applies to LYNX Touch only)
Alarm Report Delay	Disable or select the time delay for alarm reporting (applies to LYNX Touch only)
Swinger Shutdown	Select the number of times reports are sent and sounder sounds for non-fire alarms before the system ignores subsequent alarms (applies to LYNX Touch SIA only)
Abort Window	Select the time delay for alarm reporting (applies to LYNX Touch SIA only)
First Offset Report	Select the time for the first test report following power-up/programming or downloading
Report Frequency	Select the test report frequency
<b>Downloader</b>	
Phone Answer	Enable or disable to allow control to answer incoming phone line.
Modem Speed	(Future Use)
Ans. Machine Defeat	Enable to defeat answering machine mode. (Active if Phone Answer is enabled.)
Ring Counter	Enter the number of rings before control picks up phone line. (Active if Ans. Machine Defeat is not enabled.)
Callback Number	Enter the phone number the control will use to call back the downloading computer. (Active if Phone Answer is enabled.)
Flexible Callback	Allows Download operator to temporarily change the callback number by the number of digits selected. Active if Phone Answer is enabled
Number	Enter the number of flexible callback numbers that will be used. Active if Flexible Callback is enabled.

**Programming the Control**

**Notes:** If applicable, preprogrammed defaults for the LYNX Touch Control are shown on the screen unless otherwise noted. When GSM is used as the Primary Communications channel for any Total Connect service, the GSM Radio must be selected as the Primary Reporting Path (Preferred Radio).

SCREEN	ACTION								
<p><b>Reporter</b></p>	<p>Select "Reporter" The System displays the following options:</p> <table border="0" style="width: 100%;"> <tr> <td style="width: 50%;">Primary CS Info</td> <td style="width: 50%;">Secondary CS Info</td> </tr> <tr> <td>Follow Me Phone 1</td> <td>Follow Me Phone 2</td> </tr> <tr> <td>Report Selection</td> <td>Options</td> </tr> <tr> <td>Downloader</td> <td></td> </tr> </table>	Primary CS Info	Secondary CS Info	Follow Me Phone 1	Follow Me Phone 2	Report Selection	Options	Downloader	
Primary CS Info	Secondary CS Info								
Follow Me Phone 1	Follow Me Phone 2								
Report Selection	Options								
Downloader									
<p>Primary CS Info</p>	<p>Select "Primary CS Info". The System displays the following options:</p> <table border="0" style="width: 100%;"> <tr> <td style="width: 50%;">Phone Type</td> <td style="width: 50%;">Communicator Type</td> </tr> </table>	Phone Type	Communicator Type						
Phone Type	Communicator Type								
<p>Phone Type <b>Contact Id: 4 Digit</b></p>	<p>Select "Phone Type". The System scrolls though the following options: None Contact Id: 4 Digit Contact Id: 10 Digit SIA</p>								
<p>Communicator Type <b>None</b></p>	<p>Select "Communicator Type". The System scrolls though the following options: None GSM WiFi WiFi &amp; GSM IP <b>Note:</b> The system will display the communications (GSM or IP) paths based upon the selection made in Communicator Programming. The Communication Path selection can be enabled for either Primary Central Station or Secondary Central Station but not both. If it is enabled in one it will not be available for the other Central Station. If APL is used, GSM or IP must be selected as the Primary Communicator Type.</p>								
<p>Phone Number</p>	<p>If any option other than "None" is selected in "Phone Type" The "Phone Number" option will be displayed. Select "Phone Number". Enter the Primary Central Station Phone Number on the displayed keypad. (Up to 20 digits)</p>								
<p>Account Number <b>FFFF</b></p>	<p>If any option other than "None" is selected in "Phone Type" The "Account Number" option will be displayed. Select "Account Number". Enter the Primary Central Station Account Number on the displayed keypad.</p>								
<p>Dynamic Priority <b>Redundant Reports</b></p>	<p>If any option other than "None" is selected in "Communicator Type" The "Dynamic Priority" option will be displayed. "Select "Dynamic Priority". The system scrolls between "Redundant Reports", "Preferred Telco" and Preferred Radio".</p>								
<p>Dynamic Delay <b>30 Seconds</b></p>	<p>If any option other than "Redundant Reports" is selected in "Dynamic Priority" The "Dynamic Delay" option will be displayed. "Select "Dynamic Delay". The system scrolls between "15 Seconds", "30 Seconds", "60 Seconds" and "90 Seconds". <b>Note:</b> If GSM is selected as the primary reporting channel Dynamic Delay should be set to minimum of 60 seconds.</p>								
<p>Report All <b>Press to Report All</b></p>	<p>Select "Report All". The System toggles between "Press to Report All" and "Report All Set". If "Report All" is selected all reporting options will be "Enabled". Select the "Save" key to return to the Reporter options screen.</p>								
<p>Report Alarms <b>Enabled</b></p>	<p>Select "Report Alarms". The System toggles between "Disabled" and "Enabled". <b>SIA:</b> The LYNX Touch SIA default is "Enabled".</p>								
<p>Report Troubles <b>Enabled</b></p>	<p>Select "Report Troubles". The System toggles between "Disabled" and "Enabled". <b>SIA:</b> The LYNX Touch SIA default is "Enabled".</p>								
<p>Report Open/Close <b>Disabled</b></p>	<p>Select "Open/Close". The System toggles between "Disabled" and "Enabled". <b>SIA:</b> The LYNX Touch SIA default is "Enabled" and is not selectable.</p>								
<p>Report Tests <b>Enabled</b></p>	<p>Select "Report Tests". The System toggles between "Disabled" and "Enabled".</p>								
<p>Secondary CS Info</p>	<p>Select "Secondary CS Info". The System displays the following options:</p> <table border="0" style="width: 100%;"> <tr> <td style="width: 50%;">Phone Type</td> <td style="width: 50%;">Communicator Type</td> </tr> </table>	Phone Type	Communicator Type						
Phone Type	Communicator Type								

**Programming the Control**

SCREEN	ACTION
<p>Phone Type <b>None</b></p>	<p>Select "Phone Type". The System displays the following options: None Contact Id: 4 Digit Contact Id: 10 Digit SIA</p>
<p>Communicator Type <b>None</b></p>	<p>Select "Communicator Type". The System displays the following options: None GSM or IP <b>Note:</b> The system will display the communications path (GSM or IP) selected in Communications Programming. The path can be enabled for either primary Central Station or Secondary Central Station but not both. If it is enabled in one it will not be available for the other Central Station.</p>
<p>Phone Number</p>	<p>If any option other than "None" is selected in "Phone Type", the "Phone Number" option will be displayed. Select "Phone Number". Enter the Secondary Central Station Phone Number on the displayed keypad. (Up to 20 digits)</p>
<p>Account Number <b>FFFF</b></p>	<p>If any option other than "None" is selected in "Phone Type" The "Account Number" option will be displayed. Select "Account Number". Enter the Secondary Central Station Account Number on the displayed keypad.</p>
<p>Dynamic Priority <b>Redundant Reports</b></p>	<p>If any option other than "None" is selected in "Communicator Type" The "Dynamic Priority" option will be displayed. "Select "Dynamic Priority". The system scrolls between "Redundant Reports", "Preferred Telco" and Preferred Radio".</p>
<p>Dynamic Delay <b>30 Seconds</b></p>	<p>If any option other than "Redundant Reports" is selected in "Dynamic Priority" The "Dynamic Delay" option will be displayed. "Select "Dynamic Delay". The system scrolls between "15 Seconds", "30 Seconds", "60 Seconds" and "90 Seconds". <b>Note:</b> If GSM is selected as the primary reporting channel Dynamic Delay should be set to minimum of 60 seconds.</p>
<p>Report All <b>Press to Report All</b></p>	<p>Select "Report All". The System toggles between "Press to Report All" and "Report All Set". If "Report All" is selected all reporting options will be "Enabled". Select the "Save" key to return to the Reporter options screen.</p>
<p>Report Alarms <b>Enabled</b></p>	<p>Select "Report Alarms". The System toggles between "Disabled" and "Enabled".</p>
<p>Report Troubles <b>Enabled</b></p>	<p>Select "Report Troubles". The System toggles between "Disabled" and "Enabled".</p>
<p>Report Open/Close <b>Disabled</b></p>	<p>Select "Open/Close". The System toggles between "Disabled" and "Enabled".</p>
<p>Report Tests <b>Enabled</b></p>	<p>Select "Report Tests". The System toggles between "Disabled" and "Enabled". <b>SIA:</b> The LYNX Touch SIA default is "Enabled" and is not selectable.</p>
<p>Follow Me Phone 1</p>	<p>Select "Follow Me Phone 1" to program the "Follow Me" Reminder telephone number 1</p>
<p>Phone Type <b>None</b></p>	<p>Select "Phone Type". The System toggles between "None" and "Follow Me".</p>
<p>Phone Number</p>	<p>Select "Phone Number". Enter the "Follow Me" Phone Number 1 on the displayed keypad.</p>
<p>Report All <b>Press to Report All</b></p>	<p>Select "Report All". The System toggles between "Press to Report All" and "Report All Set". If "Report All" is selected all reporting options will be "Enabled". Select the "Save" key to return to the Reporter options screen.</p>
<p>Report Alarms <b>Disabled</b></p>	<p>Select "Report Alarms". The System toggles between "Disabled" and "Enabled".</p>
<p>Report Troubles <b>Disabled</b></p>	<p>Select "Report Troubles". The System toggles between "Disabled" and "Enabled".</p>

**Programming the Control**

SCREEN	ACTION		
Report Open/Close <b>Disabled</b>	Select "Open/Close". The System toggles between "Disabled" and "Enabled".		
Report Tests <b>Disabled</b>	Select "Report Tests". The System toggles between "Disabled" and "Enabled".		
Follow Me Phone 2	Select "Follow Me Phone 2" to program the "Follow Me" Reminder telephone number 2.		
Phone Type <b>None</b>	Select "Phone Type". The System toggles between "None" and "Follow Me".		
Phone Number	Select "Phone Number". Enter the "Follow Me" Phone Number 2 on the displayed keypad.		
Report All <b>Press to Report All</b>	Select "Report All". The System toggles between "Press to Report All" and "Report All Set". If "Report All" is selected all reporting options will be "Enabled". Select the "Save" key to return to the Reporter options screen.		
Report Alarms <b>Enabled</b>	Select "Report Alarms". The System toggles between "Disabled" and "Enabled".		
Report Troubles <b>Enabled</b>	Select "Report Troubles". The System toggles between "Disabled" and "Enabled".		
Report Open/Close <b>Disabled</b>	Select "Open/Close". The System toggles between "Disabled" and "Enabled".		
Report Tests <b>Enabled</b>	Select "Report Tests". The System toggles between "Disabled" and "Enabled".		
Report Selection	<p>Select "Report Selection". The System displays the following options:</p> <table border="0" style="width: 100%; border-collapse: collapse;"> <tr> <td style="width: 50%; text-align: center; vertical-align: top;">                     Arm Away Disarm Recent Closing Trouble Alarm Restore Test Bypass AC Loss Low Battery RF Low Battery                 </td> <td style="width: 50%; text-align: center; vertical-align: top;">                     Arm Stay Exit Error Event Log Full Trouble Restore Alarm Cancel Test Restore Bypass Restore AC Loss Restore Low Battery Restore RF Low Battery Restore                 </td> </tr> </table> <p>Use the down ▼ arrow to scroll to the next page of options.</p> <p>Use the down ▼ arrow to scroll to the next page of options.</p>	Arm Away Disarm Recent Closing Trouble Alarm Restore Test Bypass AC Loss Low Battery RF Low Battery	Arm Stay Exit Error Event Log Full Trouble Restore Alarm Cancel Test Restore Bypass Restore AC Loss Restore Low Battery Restore RF Low Battery Restore
Arm Away Disarm Recent Closing Trouble Alarm Restore Test Bypass AC Loss Low Battery RF Low Battery	Arm Stay Exit Error Event Log Full Trouble Restore Alarm Cancel Test Restore Bypass Restore AC Loss Restore Low Battery Restore RF Low Battery Restore		
Arm Away <b>Enabled</b>	Select "Arm Away". The System toggles between "Disabled" and "Enabled".		
Arm Stay <b>Enabled</b>	Select "Arm Stay". The System toggles between "Disabled" and "Enabled".		
Disarm <b>Enabled</b>	Select "Disarm". The System toggles between "Disabled" and "Enabled".		
Exit Error <b>Enabled</b>	Select "Exit Error". The System toggles between "Disabled" and "Enabled". <b>SIA:</b> The LYNX Touch SIA default is "Enabled" and is not selectable.		
Recent Closing <b>Enabled</b>	Select "Recent Closing". The System toggles between "Disabled" and "Enabled". <b>SIA:</b> The LYNX Touch SIA default is "Enabled" and is not selectable.		
Event Log Full <b>Enabled</b>	Select "Event Log Full". The System toggles between "Disabled" and "Enabled".		

**Programming the Control**

SCREEN	ACTION																
<p>Trouble <b>Enabled</b></p>	<p>Select "Trouble". The System toggles between "Disabled" and "Enabled".</p>																
<p>Trouble Restore <b>Enabled</b></p>	<p>Select "Trouble Restore". The System toggles between "Disabled" and "Enabled".</p>																
<p>Alarm Restore <b>Enabled</b></p>	<p>Select "Alarm Restore". The System toggles between "Disabled" and "Enabled".</p>																
<p>Alarm Cancel <b>Enabled</b></p>	<p>Select "Alarm Cancel". The System toggles between "Disabled" and "Enabled".</p>																
<p>Test <b>Enabled</b></p>	<p>Select "Test". The System toggles between "Disabled" and "Enabled". <b>SIA:</b> The LYNX Touch SIA default is "Enabled" and is not selectable.</p>																
<p>Test Restore <b>Enabled</b></p>	<p>Select "Test Restore". The System toggles between "Disabled" and "Enabled". <b>SIA:</b> The LYNX Touch SIA default is "Enabled" and is not selectable.</p>																
<p>Bypass <b>Enabled</b></p>	<p>Select "Bypass". The System toggles between "Disabled" and "Enabled".</p>																
<p>Bypass Restore <b>Enabled</b></p>	<p>Select "Bypass Restore". The System toggles between "Disabled" and "Enabled".</p>																
<p>AC Loss <b>Enabled</b></p>	<p>Select "AC Loss". The System toggles between "Disabled" and "Enabled".</p>																
<p>AC Loss Restore <b>Enabled</b></p>	<p>Select "AC Loss Restore". The System toggles between "Disabled" and "Enabled".</p>																
<p>Low Battery <b>Enabled</b></p>	<p>Select "Low Battery". The System toggles between "Disabled" and "Enabled".</p>																
<p>Low Battery Restore <b>Enabled</b></p>	<p>Select "Low Battery Restore". The System toggles between "Disabled" and "Enabled".</p>																
<p>RF Low Battery <b>Enabled</b></p>	<p>Select "RF Low Battery". The System toggles between "Disabled" and "Enabled".</p>																
<p>RF Low Battery Restore <b>Enabled</b></p>	<p>Select "RF Low Battery Restore". The System toggles between "Disabled" and "Enabled".</p>																
<p>Options</p>	<p>Select "Options". The System displays the following options:</p> <table border="0" style="width: 100%;"> <tr> <td colspan="2"><b>LYNX Touch Control</b></td> </tr> <tr> <td style="width: 50%;">PBX</td> <td style="width: 50%;">Call Wait Cancel</td> </tr> <tr> <td>Number of Reports</td> <td>Alarm Report Delay</td> </tr> <tr> <td>First Report Offset</td> <td>Report Frequency</td> </tr> <tr> <td colspan="2"><b>LYNX Touch SIA Control</b></td> </tr> <tr> <td>PBX</td> <td>Call Wait Cancel</td> </tr> <tr> <td>First Report Offset</td> <td>Swinger Shutdown</td> </tr> <tr> <td>Abort Window</td> <td>Report Frequency</td> </tr> </table>	<b>LYNX Touch Control</b>		PBX	Call Wait Cancel	Number of Reports	Alarm Report Delay	First Report Offset	Report Frequency	<b>LYNX Touch SIA Control</b>		PBX	Call Wait Cancel	First Report Offset	Swinger Shutdown	Abort Window	Report Frequency
<b>LYNX Touch Control</b>																	
PBX	Call Wait Cancel																
Number of Reports	Alarm Report Delay																
First Report Offset	Report Frequency																
<b>LYNX Touch SIA Control</b>																	
PBX	Call Wait Cancel																
First Report Offset	Swinger Shutdown																
Abort Window	Report Frequency																
<p>PBX</p>	<p>Select "PBX", and enter PBX Prefix on the displayed keypad.</p>																
<p>Call Wait Cancel</p>	<p>Select "Call Wait Cancel", and enter Call Wait Cancel Prefix on the displayed keypad</p>																

## **Programming the Control**

SCREEN	ACTION		
<p>Number of Reports <b>Unlimited</b></p>	<p>Select "Number of Reports" <b>LYNX Touch Control</b> The system toggles between "Unlimited" and "10 Reports". <b>LYNX Touch SIA Control</b> The system scrolls between the following options: 1, 2, 3, 4, 5 and 6 Reports</p>		
<p>Alarm Report Delay <b>No Delay</b></p>	<p>Select "Alarm Report Delays". The System scrolls between the following options:</p> <table border="0" style="width: 100%;"> <tr> <td style="width: 50%; vertical-align: top;"> <p><b>LYNX Touch</b> 15sec 30sec 45sec No delay</p> </td> <td style="width: 50%; vertical-align: top;"> <p><b>LYNX Touch SIA</b> 15sec 30sec 45sec</p> </td> </tr> </table> <p><b>SIA</b> The Alarm Report Delay (burglary abort window) must be set to a minimum of 15 seconds. The sum of the burglary abort window and the entry delays should not exceed 1 minute. <b>Note:</b> The LYNX Touch SIA control validates the data entered in this field. If the selection is not valid the control will emit a single long beep indicating that the selection has been rejected. The control replaces the selection with the default value "30sec".</p>	<p><b>LYNX Touch</b> 15sec 30sec 45sec No delay</p>	<p><b>LYNX Touch SIA</b> 15sec 30sec 45sec</p>
<p><b>LYNX Touch</b> 15sec 30sec 45sec No delay</p>	<p><b>LYNX Touch SIA</b> 15sec 30sec 45sec</p>		
<p>First Report Offset <b>6 Hrs</b></p>	<p>Select "First Report Offset" for the Test Report. The System scrolls between the following options: 6 Hrs 12 Hrs 18 Hrs 24 Hrs</p>		
<p>Report Frequency <b>Never</b></p>	<p>Select "Report Frequency" for the Test Report. The System scrolls between the following options: Never Every Day Every 7 Days Every 30 Days</p>		
<p>Downloader</p>	<p>Select "Downloader". The System displays the following options:</p> <table border="0" style="width: 100%;"> <tr> <td style="width: 50%; vertical-align: top;"> <p>Phone Answer Ans.Machine Defeat Ring Counter</p> </td> <td style="width: 50%; vertical-align: top;"> <p>Modem Speed Callback Number Flexible Callback Number</p> </td> </tr> </table>	<p>Phone Answer Ans.Machine Defeat Ring Counter</p>	<p>Modem Speed Callback Number Flexible Callback Number</p>
<p>Phone Answer Ans.Machine Defeat Ring Counter</p>	<p>Modem Speed Callback Number Flexible Callback Number</p>		
<p>Phone Answer <b>Yes</b></p>	<p>Select "Phone Answer", the system toggles between "Yes" and "No".</p>		
<p>Modem Speed <b>Slow</b></p>	<p>(Future Use)</p>		
<p>Ans. Machine Defeat <b>Yes</b></p>	<p>Select "Ans. Machine Defeat", the system toggles between "Yes" and "No".</p>		
<p>Callback Number</p>	<p>Select "Callback Number" and enter callback number on the displayed keypad.</p>		
<p>Ring Counter <b>2</b></p>	<p>This option only appears if Answering Machine defeat is set to "No". Enter ring counter (1 – 14 rings) on the displayed keypad.</p>		
<p>Flexible Callback <b>No</b></p>	<p>Select "Flexible Callback", the system toggles between "Yes" and "No".</p>		
<p>Number <b>1</b></p>	<p>This option only appears if "Flexible Callback" is set to "Yes". The system scrolls between options 1, 2 and 3.</p>		

## Programming the Control Sounder

The following system options are programmed in this section:

Option	Function
Burglary Alarm Sound	Switches the full 110 dB alarm sound for burglary On/Off.
Burglary Bell Timeout	Select the time for timeout of the Burglary Alarm sounder.
Fire Bell Timeout	Select the time for timeout of the Fire Alarm sounder.
Arm Confirm	Enable sounder "ding" when system is armed via the selected RF device.
Alarm Options	Select a limit for the number of times an alarm can sound for a specific zone. <b>Note:</b> This option does not apply to the LYNX Touch SIA control.

**Note:** If applicable, preprogrammed defaults for the LYNX Touch Control are shown on the screen unless otherwise noted.

SCREEN	ACTION
<div style="border: 1px solid black; padding: 5px; width: fit-content; margin: auto;"> <b>Sounder</b> </div>	Select "Sounder" The System displays the following options: <div style="display: flex; justify-content: space-around;"> <span>Burglary Alarm Sound</span> <span>Burglary Bell Timeout</span> </div> <div style="display: flex; justify-content: space-around;"> <span>Fire Bell Timeout</span> <span>Arm Confirm</span> </div> <span>Alarm Options</span>
<div style="border: 1px solid black; padding: 5px; width: fit-content; margin: auto;">                     Burglary Alarm Sound  <b>Yes</b> </div>	Select "Burglary Alarm Sound". The System toggles between Yes* and No:
<div style="border: 1px solid black; padding: 5px; width: fit-content; margin: auto;">                     Burglary Bell Timeout  <b>4 Minutes</b> </div>	Select "Burglary Bell Timeout". The System scrolls between the following options: No 4 Minutes 8 Minutes 12 Minutes 16 Minutes
<div style="border: 1px solid black; padding: 5px; width: fit-content; margin: auto;">                     Fire Bell Timeout  <b>4 Minutes</b> </div>	Select "Fire Bell Timeout". The System scrolls between the following options: No 4 Minutes 8 Minutes 12 Minutes 16 Minutes
<div style="border: 1px solid black; padding: 5px; width: fit-content; margin: auto;">                     Arm Confirm  <b>None</b> </div>	Select "Arm Confirm". The System scrolls between the following options: None All RF RF Key Fob RF Keypad
<div style="border: 1px solid black; padding: 5px; width: fit-content; margin: auto;">                     Alarm Options  <b>Unlimited</b> </div>	<b>Note:</b> This option does not apply to the LYNX Touch SIA Control. Select "Alarm Options". The System scrolls between the following options: Unlimited 1 2 10 Select "Save".

## **Programming the Control**

### **System Settings**

The following system options are programmed in this section:

<b>Option</b>	<b>Function</b>
Entry Delay1/Entry Delay 2	Selects an Entry Delay time in seconds. The system will wait the time entered before sounding alarm upon entering if system is not disarmed. <b>Note:</b> The Default values differ for the LYNX Touch and LYNX Touch SIA controls.
Exit Delay	Selects an Exit Delay time in seconds for both Entry Delay 1 and 2 Zone Types. The system will wait the time entered before sounding an alarm if the exit door is left open after the system has been armed. <b>Note:</b> The Default values differ for the LYNX Touch and LYNX Touch SIA controls.
Backlight Timeout	Enable or disable display backlight turnoff after 30 seconds.
Quick Arm	Enables or disables Quick Arm Mode. If enabled, security code is not required to arm the system. The user simply presses the AWAY button (ICON) and then selects the "Quick Arm" button on the displayed keypad to arm the system.
Quick Exit	Enables or disables Quick Exit Mode. If enabled allows the user restart the exit delay to allow entry or exit when the system is armed
Restart Exit Time	Enables or disables Restart Exit Time Mode. This option allows the control to restart the exit delay time after arming in STAY mode by entering the User Code and pressing the STAY key (if quick arming is disabled) or by pressing the STAY key (if quick arming is enabled). This option also enables automatic exit delay reset, which resets exit delay if the entry/exit door is re-opened and closed before exit delay time expires after arming.
Force Bypass	Enables or disables Force Bypass Mode. All zones bypassed by this function will be displayed after the bypass is initiated. The Fire and CO Zones are not bypassed in the LYNX Touch.
Exit Warning	Enables or disables Exit Warning sound. Audible Exit Warning sound consists of slow continuous beeps until last 10 seconds, when it changes to fast beeps. The warning sound will end at the termination of exit delay. <b>Note:</b> This field is not programmable in the LYNX Touch SIA and is always enabled.
Auto Stay Arming	Enables or disables Auto Stay Arming Mode. If this feature is enabled and the control panel has been armed "Armed Away" at the LYNX Touch keypad or RF keypad, the system will switch to the "Armed Stay" mode if the Exit Time has expired and no exit has been made.
Lack of Usage Notify	Enables or disables Lack of Usage Notification feature. If enabled, notifies the central station if an end user is not operating their security system by sending a System Inactivity report 654. The report will be sent only to the Primary phone number and only if Contact ID® format was selected.
Power-Up in Previous	Enables or disables Power-Up in Previous Mode feature. When the system powers up armed, an alarm will occur 1 minute after arming if a zone is faulted. For the LYNX Touch control any bypassed zones will be unbypassed. For the LYNX Touch SIA any bypassed zones will remain bypassed.
Display Alarm Cancel	Enables or disables display of Cancelled Alarm.
Display Exit Time	Enables or disables display of Exit Time.
Cross Zone Delay	Sets the maximum amount of time in which two zones must be tripped in an armed system to send an alarm message to the Central Station. If only one cross zone is tripped during this time, a trouble message (CID code 380) for that zone is sent to the Central Station.
Cross Zone 1/Cross Zone 2	Select the zones that will be used for Cross Zoning



Programming the Control

Note: If applicable, preprogrammed defaults for the LYNX Touch Control are shown on the screen unless otherwise noted.

SCREEN	ACTION																		
<p style="text-align: center;"><b>System Settings</b></p>	<p>Select "System Settings" The System displays the following options:</p> <table style="width: 100%; border: none;"> <tr> <td style="width: 50%; border-right: 1px solid black; padding-right: 5px;">Entry Delay 1</td> <td style="width: 50%; padding-left: 5px;">Entry Delay 2</td> </tr> <tr> <td style="border-right: 1px solid black; padding-right: 5px;">Exit Delay</td> <td style="padding-left: 5px;">Backlight Timeout</td> </tr> <tr> <td style="border-right: 1px solid black; padding-right: 5px;">Quick Arm</td> <td style="padding-left: 5px;">Quick Exit</td> </tr> <tr> <td style="border-right: 1px solid black; padding-right: 5px;">Force Bypass</td> <td style="padding-left: 5px;">Restart Exit Time</td> </tr> <tr> <td style="border-right: 1px solid black; padding-right: 5px;"></td> <td style="padding-left: 5px;">Auto Stay Arming</td> </tr> </table> <p>Use the down ▼ arrow to scroll to the next page of options. Use the ▲ arrow to return to the previous page:</p> <table style="width: 100%; border: none;"> <tr> <td style="width: 50%; border-right: 1px solid black; padding-right: 5px;">Lack of Usage Notify</td> <td style="width: 50%; padding-left: 5px;">Power-Up In Previous</td> </tr> <tr> <td style="border-right: 1px solid black; padding-right: 5px;">Display Alarm Cancel</td> <td style="padding-left: 5px;">Display Exit Time</td> </tr> <tr> <td style="border-right: 1px solid black; padding-right: 5px;"></td> <td style="padding-left: 5px;">Cross Zone Delay</td> </tr> <tr> <td style="border-right: 1px solid black; padding-right: 5px;">Cross Zone 1</td> <td style="padding-left: 5px;">Cross Zone 2</td> </tr> </table>	Entry Delay 1	Entry Delay 2	Exit Delay	Backlight Timeout	Quick Arm	Quick Exit	Force Bypass	Restart Exit Time		Auto Stay Arming	Lack of Usage Notify	Power-Up In Previous	Display Alarm Cancel	Display Exit Time		Cross Zone Delay	Cross Zone 1	Cross Zone 2
Entry Delay 1	Entry Delay 2																		
Exit Delay	Backlight Timeout																		
Quick Arm	Quick Exit																		
Force Bypass	Restart Exit Time																		
	Auto Stay Arming																		
Lack of Usage Notify	Power-Up In Previous																		
Display Alarm Cancel	Display Exit Time																		
	Cross Zone Delay																		
Cross Zone 1	Cross Zone 2																		
<p style="text-align: center;">Entry Delay 1 <b>30 Seconds</b></p>	<p>Select "Entry Delay 1". The System scrolls between the following options:</p> <table style="width: 100%; border: none;"> <tr> <td style="width: 50%; border-right: 1px solid black; padding-right: 5px;"><b>LYNX Touch</b></td> <td style="width: 50%; padding-left: 5px;"><b>LYNX Touch SIA</b></td> </tr> <tr> <td style="border-right: 1px solid black; padding-right: 5px;">None</td> <td style="padding-left: 5px;">30 Seconds</td> </tr> <tr> <td style="border-right: 1px solid black; padding-right: 5px;">15 Seconds</td> <td style="padding-left: 5px;">45 Seconds</td> </tr> <tr> <td style="border-right: 1px solid black; padding-right: 5px;">30 Seconds</td> <td style="padding-left: 5px;">60 Seconds</td> </tr> <tr> <td style="border-right: 1px solid black; padding-right: 5px;">45 Seconds</td> <td style="padding-left: 5px;">90 Seconds</td> </tr> <tr> <td style="border-right: 1px solid black; padding-right: 5px;">60 Seconds</td> <td style="padding-left: 5px;">2 Minutes</td> </tr> <tr> <td style="border-right: 1px solid black; padding-right: 5px;">90 Seconds</td> <td style="padding-left: 5px;">3 Minutes</td> </tr> <tr> <td style="border-right: 1px solid black; padding-right: 5px;">2 Minutes</td> <td style="padding-left: 5px;">4 Minutes</td> </tr> </table> <p><b>UL installations:</b> The Entry Delay must be set for a maximum of 45 seconds <b>SIA:</b> The Entry delay must be set to a minimum of 30 seconds. The sum of entry delay 1 and the burglary abort window should not exceed 1 minute.</p>	<b>LYNX Touch</b>	<b>LYNX Touch SIA</b>	None	30 Seconds	15 Seconds	45 Seconds	30 Seconds	60 Seconds	45 Seconds	90 Seconds	60 Seconds	2 Minutes	90 Seconds	3 Minutes	2 Minutes	4 Minutes		
<b>LYNX Touch</b>	<b>LYNX Touch SIA</b>																		
None	30 Seconds																		
15 Seconds	45 Seconds																		
30 Seconds	60 Seconds																		
45 Seconds	90 Seconds																		
60 Seconds	2 Minutes																		
90 Seconds	3 Minutes																		
2 Minutes	4 Minutes																		
<p style="text-align: center;">Entry Delay 2 <b>60 Seconds</b></p>	<p>Select "Entry Delay 2". The System scrolls between the following options:</p> <table style="width: 100%; border: none;"> <tr> <td style="width: 50%; border-right: 1px solid black; padding-right: 5px;"><b>LYNX Touch</b></td> <td style="width: 50%; padding-left: 5px;"><b>LYNX Touch SIA</b></td> </tr> <tr> <td style="border-right: 1px solid black; padding-right: 5px;">None</td> <td style="padding-left: 5px;">30 Seconds</td> </tr> <tr> <td style="border-right: 1px solid black; padding-right: 5px;">15 Seconds</td> <td style="padding-left: 5px;">45 Seconds</td> </tr> <tr> <td style="border-right: 1px solid black; padding-right: 5px;">30 Seconds</td> <td style="padding-left: 5px;">60 Seconds</td> </tr> <tr> <td style="border-right: 1px solid black; padding-right: 5px;">45 Seconds</td> <td style="padding-left: 5px;">90 Seconds</td> </tr> <tr> <td style="border-right: 1px solid black; padding-right: 5px;">60 Seconds</td> <td style="padding-left: 5px;">2 Minutes</td> </tr> <tr> <td style="border-right: 1px solid black; padding-right: 5px;">90 Seconds</td> <td style="padding-left: 5px;">3 Minutes</td> </tr> <tr> <td style="border-right: 1px solid black; padding-right: 5px;">2 Minutes</td> <td style="padding-left: 5px;">4 Minutes</td> </tr> </table> <p><b>UL installations:</b> The Entry Delay must be set for a maximum of 45 seconds <b>SIA:</b> The Entry delay must be set to a minimum of 30 seconds. The sum of entry delay 2 and the burglary abort window should not exceed 1 minute. The LYNX Touch SIA default is "60 Seconds".</p>	<b>LYNX Touch</b>	<b>LYNX Touch SIA</b>	None	30 Seconds	15 Seconds	45 Seconds	30 Seconds	60 Seconds	45 Seconds	90 Seconds	60 Seconds	2 Minutes	90 Seconds	3 Minutes	2 Minutes	4 Minutes		
<b>LYNX Touch</b>	<b>LYNX Touch SIA</b>																		
None	30 Seconds																		
15 Seconds	45 Seconds																		
30 Seconds	60 Seconds																		
45 Seconds	90 Seconds																		
60 Seconds	2 Minutes																		
90 Seconds	3 Minutes																		
2 Minutes	4 Minutes																		
<p style="text-align: center;">Exit Delay <b>60 Seconds</b></p>	<p>Select "Exit Delay". The System toggles between the following options:</p> <table style="width: 100%; border: none;"> <tr> <td style="width: 50%; border-right: 1px solid black; padding-right: 5px;"><b>LYNX Touch</b></td> <td style="width: 50%; padding-left: 5px;"><b>LYNX Touch SIA</b></td> </tr> <tr> <td style="border-right: 1px solid black; padding-right: 5px;">None</td> <td style="padding-left: 5px;">45 Seconds</td> </tr> <tr> <td style="border-right: 1px solid black; padding-right: 5px;">15 Seconds</td> <td style="padding-left: 5px;">60 Seconds</td> </tr> <tr> <td style="border-right: 1px solid black; padding-right: 5px;">30 Seconds</td> <td style="padding-left: 5px;">90 Seconds</td> </tr> <tr> <td style="border-right: 1px solid black; padding-right: 5px;">45 Seconds</td> <td style="padding-left: 5px;">2 Minutes</td> </tr> <tr> <td style="border-right: 1px solid black; padding-right: 5px;">60 Seconds</td> <td></td> </tr> <tr> <td style="border-right: 1px solid black; padding-right: 5px;">90 Seconds</td> <td></td> </tr> <tr> <td style="border-right: 1px solid black; padding-right: 5px;">2 Minutes</td> <td></td> </tr> </table> <p><b>UL installations:</b> Exit Delay must be set for a maximum of 60 seconds <b>SIA:</b> The Exit Delay must be set to a minimum of 45 seconds.</p>	<b>LYNX Touch</b>	<b>LYNX Touch SIA</b>	None	45 Seconds	15 Seconds	60 Seconds	30 Seconds	90 Seconds	45 Seconds	2 Minutes	60 Seconds		90 Seconds		2 Minutes			
<b>LYNX Touch</b>	<b>LYNX Touch SIA</b>																		
None	45 Seconds																		
15 Seconds	60 Seconds																		
30 Seconds	90 Seconds																		
45 Seconds	2 Minutes																		
60 Seconds																			
90 Seconds																			
2 Minutes																			
<p style="text-align: center;">Backlight Timeout <b>No</b></p>	<p>Select "Backlight Timeout". The System toggles between No and 30 Seconds.</p>																		
<p style="text-align: center;">Quick Arm <b>Yes</b></p>	<p>Select "Quick Arm". The System toggles between Yes and No.</p>																		

## **Programming the Control**

SCREEN	ACTION
Quick Exit <b>Yes</b>	Select "Quick Exit". The System toggles between Yes and No.
Restart Exit Time <b>No</b>	Select "Restart Exit Time". The System toggles between Yes and No. <b>SIA:</b> The LYNX Touch SIA default is "Yes".
Force Bypass <b>No</b>	Select "Force Bypass". The System toggles between Yes and No. <b>UL installations:</b> must be NO (no forced bypass)
Exit Warning <b>No</b>	Select "Exit Warning". The System toggles between Yes and No. <b>SIA:</b> The LYNX Touch SIA default is "Enabled" and is not selectable.
Auto Stay Arming <b>No</b>	Select "Auto Stay Arming". The System toggles between Yes and No. <b>SIA:</b> The LYNX Touch SIA default is "Yes".
Lack of Usage Notify <b>Disabled</b>	Select "Lack of Usage Notify". The System scrolls between the following options: Disabled 1 Day 7 Days 27 Days 90 Days 180 Days 365 Days
Power-Up In Previous <b>Yes</b>	Select "Power-Up In Previous". The System toggles between Yes and No. <b>Note:</b> If the previous state was Armed Away or Stay, the system will not respond to sensor changes for 1 minute. This allows time for sensors such as PIRs to stabilize. <b>UL installations:</b> must be Yes (power up in previous state) <b>SIA:</b> The LYNX Touch SIA default is "Enabled" and is not selectable.
Display Alarm Cancel <b>No</b>	Select "Display Alarm Cancel". The System toggles between Yes and No.
Display Exit Time <b>Yes</b>	Select "Display Exit Time". The System toggles between Yes and No.
Cross Zone Delay <b>3 Minutes</b>	Select "Cross Zone Delay". The System toggles between the following: None 30 Seconds 1 Minute 90 Seconds 2 Minutes 3 Minutes 4 Minutes <b>Note:</b> Cross zoning can not be used in conjunction with APL.
Cross Zone 1 <b>Disabled</b>	Select "Cross Zone 1". The System toggles between the following: Disabled <b>Note:</b> If Cross Zone Delay is enabled the system will display the zones that are programmed with the following Zone Types: Day/Night, Interior Follower and perimeter.
Cross Zone 2 <b>Disabled</b>	Select "Cross Zone 2". The System toggles between the following: Disabled <b>Note:</b> If Cross Zone Delay is enabled the system will display the zones that are programmed with the following Zone Types: Day/Night, Interior Follower and perimeter.

## Programming the Control Communications Diagnostics

**Communications Status** – The system provides a status of the IP or GSM communications paths and performs a self-test of the AES encryption algorithm as follows:

Message		Meaning
GSM: OR IP:	OK	Normal; No fault. (IP or GSM)
	Fault Reported!	No network connectivity and fault time has expired. (IP or GSM)
	Not Connected	No network connectivity over IP and fault time has NOT yet expired.
	Not Registered!	No network connectivity over GSM and fault time has NOT yet expired.
	No Physical Link	No network connectivity over IP and fault time is set to 0.
Encryption:	AES Passed!	Test successful.
	AES Failed!	Test failed.
	No Encryption!	No encryption algorithm set.
Alarmnet Registration:	Registered	Communication Device is Registered with AlarmNet.
	Not Registered	Communication Device is not Registered with AlarmNet.

**Ethernet Information** – Displays IP information, if IP communication path is enabled.

Physical Link: Indicates status of the physical connection to the internet.  
 DHCP: DHCP (Dynamic Host Configuration Protocol) indicated server is performing satisfactorily.  
 NIC IP Address: Displays the IP address assigned to this device  
 Subnet Mask: Displays the 32-bit address mask used to indicate the portion (bits) of the IP address that is being used for the subnet address.  
 Gateway IP Address: Displays the IP address assigned to the Gateway.  
 DNS Server IP Address: Displays the IP address assigned to the DNS (Domain Name System) server.

Message		Meaning
Physical Link	10 Mbps or 100 Mbps	Link speed of physical connection
	Bad	No physical connection
DHCP	OK	DHCP address resolved
	Bad	DHCP address not resolved
	Off	DHCP disabled

**GSM Information** – Displays GSM information if GSM communication path is enabled.

Status	Message		Meaning
GSM Registered	Cell Registration:	Home 2G	Registered Home with 2G Service
		Home 3G	Registered Home with 3G/4G Service
		Roaming	Registered Roaming
	Primary RSSI:	(See RSSI Note below)	Primary Site RSSI level signal strength (1 to 5 stars or "Not Present" will be displayed)
		GPRS: (2G Only) (Always available in 3G/4G)	Yes No
	Country:	xxx	Country Code
	Network:	xxx	Network Code
	LAC	xxxxx	Local Area Code
	Cell: (2G only) Cell: (3G/4G only)	xxxx	Base Station ID
		xxxxxx	Base Station ID
	Base Station: (2G Only)	xx	Base Station Antenna Sector
	Primary Sync Code (3G/4G Only)	xxx	Primary Sync Code
	Channel:	xxxx	Control Channel in use
	Second Site RSSI:	(See RSSI Note below)	Secondary Site RSSI level availability ("Present" OR "Not present" will be displayed)
GSM Not Registered	Searching For Coverage!		Searching for cell network.
	SIM Error!		No SIM card present or SIM card faulty
	Cell Registration: SIM Not Active		SIM is not activated
	Cell Registration: Not Registered		Not registered with cell network

**RSSI Note:** Primary Site Signal strength is displayed by a series of 1 to 5 stars (\* weak to \*\*\*\*\* strong) or "Not Present" if there is no signal. To ensure a reliable installation at least 2 (\*\*) stars should consistently be present. Secondary site presence is indicated by "Present" or "Not Present".

## **Programming the Control**

### **Communications ID Numbers – Displays programmed SIM card information**

<b>Message</b>		<b>Meaning</b>
MAC:	xxxxxxxxxxxx	MAC Address indicates the unique identification number for installed communications module(s)
MAC CRC:	xxxx	MAC CRC number for installed communications module(s)
WiFi:*	xxxxxxxxxxxx	Physical MAC Address of the WiFi module
WiFi Ver:	x.x.x	WiFi module software version
SCID:**	xxxxxxxxxxxxxxxxxxxx	Displays the ID number assigned to the installed SIM card (SCID)
IMEI:**	xxxxxxxxxxxxxxx	Displays the ID number assigned to the installed GSM module.

\* This is the system MAC that should be referenced whenever speaking with technical support.

\*\* Displayed if GSM communication path is enabled.

**Test Communications –** Performs network diagnostics and sends test alarms to AlarmNet. The following tests are available depending on the type of communications module installed.

#### **Test Ethernet**

This test is available if IP communication path is enabled. The network diagnostic process tests the integrity of the links between the LYNX Touch and the various connection points of AlarmNet Control that are known as “Redirectors”. If a physical link is detected and is ready, the following diagnostics are performed.

Testing Gateway... Traces the connection to the Gateway and displays the following:

Testing Gateway – Successful!      A successful trace to Gateway. OR  
Testing Gateway – Failed!            Failed to reach Gateway.

Testing Redirector \* Sequentially traces the connection to Redirector 1, 2 and 3 at AlarmNet Control. The following will be displayed.

Redirector \* – Service OK      Service at AlarmNet Control on Redirector 1, 2 or 3 is functioning. OR  
Redirector \* – Failed            Error occurred on Redirector 1, 2 or 3.

\* = Number of the director being tested is displayed

A summary of the tests is displayed after Redirector 3 is tested. The example shows that the tests of all three connection points, or Redirectors, were successful. If an error occurred at any point, the summary will display “Failed” next to the faulty Redirector.

Redirector 1 – Service OK  
Redirector 2 – Service OK  
Redirector 3 – Service OK

If no physical link is detected, the test is aborted and one of the following is displayed:

No Physical Link            No physical link is detected.  
Link Not Ready              There is a link but it is not ready (address not resolved).

#### **Send Any**

If both IP and GSM communication paths are enabled and the LYNX Touch is registered, a Test alarm is sent over IP path. If that is not successful, it sends the alarm over GSM path and the following message is displayed: **Test Message Sent**

If the device is not registered, the following is displayed: **Test Message Failed – Not Registered**

#### **Send GSM Message**

If GSM communication path is enabled and the LYNX Touch is registered, a Test alarm to AlarmNet over the GSM path. The following message is displayed: **Test Message Sent**

If the device is not registered, the following message is displayed: **Test Message Failed – Not Registered**

#### **Send Ethernet Message**

If IP communication path is enabled and the LYNX Touch is registered, a Test alarm to AlarmNet over the IP path. The following message is displayed: **Test Message Sent**

If the device is not registered, the following message is displayed: **Test Message Failed – Not Registered**

**Setup Communication –** Performs registration of the LYNX Touch and its associated communication module with AlarmNet updates configuration files or reset factory defaults.

#### **Registering the LYNX Touch**

Once the LYNX Touch is initialized and a communications module is programmed, it must be registered to enable the account. Upon completion of the registration process, the LYNX Touch transmits a registration message and receives a registration validation indicating that the account is now enabled. Wait for the “Registration Success” message to appear, regardless of which registration method is used.

You can register the communications module by one of the following methods:

- Through the AlarmNet Direct website
- By Phone
- Through the LYNX Touch Diagnostics

## Programming the Control

### Register through AlarmNet Direct Website

If you have programmed the communications module through AlarmNet Direct, you must then transfer the data to the module, and register the module.

To do this, please go to: <https://services.alarmnet.com/AlarmNetDirect/userlogin.aspx>.

Log in and follow the on-screen prompts.

If you are not signed up for this service, click on “Dealer Signup” from the login screen to gain access to the Honeywell web-based programming.

Dealer Sign-Up Direct Link: [https://services.alarmnet.com/AlarmNetDirectP\\_Sign-Up](https://services.alarmnet.com/AlarmNetDirectP_Sign-Up).

You will be instructed how to proceed upon completing the sign-up form. Only one sign-up per dealer is required. Once an initial user is established, additional logins may be created by that user.

Please have the following information available when programming the device:

1. Primary City ID (two-digit number)
2. Primary Central Station ID (two-digit hexadecimal number)
3. Primary Subscriber ID (four-digit number)
4. MAC ID and MAC CRC number (located on outside of box and on label inside module – *location to be confirmed*).

Once module is registered, you may log out of the AlarmNet Direct website.

### Register by Phone

You can register the module by calling the AlarmNet Technical Assistance Center (TAC) at 1-800-222-6525.

You will need the following information:

- MAC number (found on the label).
- Subscriber information (provided by the central station), including a city code, CSID, and a subscriber ID.
- When instructed to do so, select **Register Device** in the LYNX Touch Diagnostics to complete the registration.

### Register through LYNX Touch Diagnostics

Register the module using the LYNX Touch Diagnostics and the following procedure.

SCREEN	ACTION						
Comm. Diagnostics	<p>1. Select “Comm. Diagnostics” The System displays the following options depending upon the communication device that is installed:</p> <table style="width: 100%; border-collapse: collapse;"> <tr> <td style="text-align: center; width: 33%; border-right: 1px solid black;">WiFi Location <b>None</b></td> <td style="text-align: center; width: 33%; border-right: 1px solid black;">Configure WiFi</td> <td style="text-align: center; width: 33%;">Ethernet Information GSM Information</td> </tr> </table> <p>Use the down ▼ arrow to scroll to the next page of options. Use the ▲ arrow to return to the previous page:</p> <table style="width: 100%; border-collapse: collapse;"> <tr> <td style="text-align: center; width: 33%; border-right: 1px solid black;">Communication Status</td> <td style="text-align: center; width: 33%; border-right: 1px solid black;">Test Communication</td> <td style="text-align: center; width: 33%;">Setup Communication Communication ID Numbers</td> </tr> </table>	WiFi Location <b>None</b>	Configure WiFi	Ethernet Information GSM Information	Communication Status	Test Communication	Setup Communication Communication ID Numbers
WiFi Location <b>None</b>	Configure WiFi	Ethernet Information GSM Information					
Communication Status	Test Communication	Setup Communication Communication ID Numbers					
Setup Communication	<p>2. Select “Setup Communication”. The System advances to the Registration screen and the following options are displayed:</p> <table style="width: 100%; border-collapse: collapse;"> <tr> <td style="text-align: center; width: 50%; border-right: 1px solid black;">Register Device Update Server</td> <td style="text-align: center; width: 50%;">Register Device With PIN Factory Defaults</td> </tr> </table> <p>3. Select “Register Device”. The registration message is sent and the unit waits for the acknowledgement. (Refer to the table below for applicable registration messages.)</p> <p><b>Note:</b> Register Device can be cancelled by selecting “Cancel”. The registration process is aborted and the message Registration Cancelled! is displayed.</p>	Register Device Update Server	Register Device With PIN Factory Defaults				
Register Device Update Server	Register Device With PIN Factory Defaults						

## Programming the Control

During the registration process the following messages may be displayed:

Message	Meaning
Getting Configuration File...	The configuration file is obtained from AlarmNet if the module was programmed through AlarmNet Direct or a previously programmed module was defaulted.
Registering...	The registration message is sent and the unit is waiting for the acknowledgement.
Registration Successful!	The module is registered and is now in full service and available for alarm reporting to the central station.
Registering – Try Later!	Error Message indicates the module is busy.
Registration Failed!	Error message followed by one of the messages below:
Invalid Configuration!	Indicates the configuration is invalid.
Timed Out.	Displayed if no response to the registration request is received.
Central Station Database Full.	Indicates CS database has more than 1000 subscribers.
Primary Sub ID Bad.	Indicates the city, central station, or customer number for the labeled account is not accepted. The ID information was either entered incorrectly, or the central station failed to pre-authorize programmed ID numbers with AlarmNet customer service.
Primary ID – Need PIN.	Indicates the city, central station, or customer number for the labeled account is not accepted. The ID information was either entered incorrectly, or the central station failed to pre-authorize programmed ID numbers with AlarmNet customer service. See the <i>Register Device With PIN</i> section.
Account Disabled.	Displayed if the account is disabled in AlarmNet.

### Register Device with PIN

This procedure is used to replace one LYNX Touch module with another.

SCREEN	ACTION						
Comm. Diagnostics	<p>1. Select “Comm. Diagnostics” The System displays the following options depending upon the communication device that is installed:</p> <table border="1"> <tr> <td>Communication Status</td> <td>Ethernet Information</td> <td>GSM Information</td> </tr> <tr> <td>Communication ID Numbers</td> <td>Test Communication</td> <td>Setup Communication</td> </tr> </table>	Communication Status	Ethernet Information	GSM Information	Communication ID Numbers	Test Communication	Setup Communication
Communication Status	Ethernet Information	GSM Information					
Communication ID Numbers	Test Communication	Setup Communication					
Setup Communication	<p>2. Select “Setup Communication”. The System advances to the Registration screen and the following options are displayed:</p> <table border="1"> <tr> <td>Register Device</td> <td>Register Device With PIN</td> </tr> <tr> <td>Update Server</td> <td>Factory Defaults</td> </tr> </table> <p>3. Select “Register Device With PIN”. Enter a 4-digit alphanumeric PIN number (provided by your central station, your dealer or an authorized AlarmNet representative) on the displayed keypad then select “Done”. (Refer to the table below for applicable registration messages.)</p> <p><b>Note:</b> <i>Register Device With PIN</i> can be cancelled by selecting “Cancel”. The registration process is aborted and the message Registration Cancelled! is displayed.</p>	Register Device	Register Device With PIN	Update Server	Factory Defaults		
Register Device	Register Device With PIN						
Update Server	Factory Defaults						

During the registration process the following messages may be displayed:

Message	Meaning
Registering...	The registration message is sent and the unit is waiting for the acknowledgement.
Registration Successful!	The PIN number is valid and module is registered and is now in full service and available for alarm reporting to the central station. The old module is unregistered. Additionally, AlarmNet sends a substitution alarm to the central station.
Registering – Try Later!	Error Message indicates the module is busy.
Registration Failed!	Error message followed by one of the messages below:
Invalid Configuration!	Indicates the configuration is invalid.
Timed Out.	Displayed if no response to the registration request is received.
Primary ID – Need PIN.	Indicates PIN that was entered is invalid.

**Programming the Control**

**Update Server**

This procedure is used to upload the Configuration File to the Server.

SCREEN	ACTION												
Comm. Diagnostics	<p>1. Select "Comm. Diagnostics" The System displays the following options depending upon the communication device that is installed:</p> <table border="0" style="width: 100%; border-collapse: collapse;"> <tr> <td style="text-align: center; width: 33%; border-right: 1px solid black;">WiFi Location <b>None</b></td> <td style="text-align: center; width: 33%; border-right: 1px solid black;">Configure WiFi</td> <td style="text-align: center; width: 33%;">Ethernet Information</td> </tr> <tr> <td></td> <td></td> <td style="text-align: center;">GSM Information</td> </tr> <tr> <td colspan="3" style="text-align: center;">Use the down ▼ arrow to scroll to the next page of options. Use the ▲ arrow to return to the previous page:</td> </tr> <tr> <td style="text-align: center; border-right: 1px solid black;">Communication Status</td> <td style="text-align: center; border-right: 1px solid black;">Test Communication</td> <td style="text-align: center;">Setup Communication Communication ID Numbers</td> </tr> </table>	WiFi Location <b>None</b>	Configure WiFi	Ethernet Information			GSM Information	Use the down ▼ arrow to scroll to the next page of options. Use the ▲ arrow to return to the previous page:			Communication Status	Test Communication	Setup Communication Communication ID Numbers
WiFi Location <b>None</b>	Configure WiFi	Ethernet Information											
		GSM Information											
Use the down ▼ arrow to scroll to the next page of options. Use the ▲ arrow to return to the previous page:													
Communication Status	Test Communication	Setup Communication Communication ID Numbers											
Setup Communication	<p>2. Select "Setup Communication". The System advances to the Registration screen and the following options are displayed:</p> <table border="0" style="width: 100%; border-collapse: collapse;"> <tr> <td style="text-align: center; width: 50%; border-right: 1px solid black;">Register Device</td> <td style="text-align: center; width: 50%;">Register Device With PIN</td> </tr> <tr> <td style="text-align: center; border-right: 1px solid black;">Update Server</td> <td style="text-align: center;">Factory Defaults</td> </tr> </table> <p>3. Select "Update Server" and select "Yes" when the confirmation screen appears. The device uploads its entire configuration file to the server. Selecting "No" will cancel the operation. (Refer to the table below for applicable registration messages.)</p>	Register Device	Register Device With PIN	Update Server	Factory Defaults								
Register Device	Register Device With PIN												
Update Server	Factory Defaults												

During the upload process the following messages may be displayed:

Message	Meaning
Updating Root File...	The root file is being uploaded.
Programming Done	Indicates the root file has been successfully uploaded.
Updating Configuration – Try Later!	Error message indicates the module is busy
Cannot Upload – Try Later!	Error message indicates the communication path(s) is not available.
Update Root File – Failed!	Error message indicates an error while uploading root file.

**Enroll the L5100-WiFi Module**

The module can be enrolled using one of the following procedures:

- Scan Access Points
- Manual Configure Access Points
- WPS (If available)

SCREEN	ACTION												
Comm. Diagnostics	<p>1. Select "Comm. Diagnostics" The System displays the following options depending upon the communication device that is installed:</p> <table border="0" style="width: 100%; border-collapse: collapse;"> <tr> <td style="text-align: center; width: 33%; border-right: 1px solid black;">WiFi Location <b>None</b></td> <td style="text-align: center; width: 33%; border-right: 1px solid black;">Configure WiFi</td> <td style="text-align: center; width: 33%;">Ethernet Information</td> </tr> <tr> <td></td> <td></td> <td style="text-align: center;">GSM Information</td> </tr> <tr> <td colspan="3" style="text-align: center;">Use the down ▼ arrow to scroll to the next page of options. Use the ▲ arrow to return to the previous page:</td> </tr> <tr> <td style="text-align: center; border-right: 1px solid black;">Communication Status</td> <td style="text-align: center; border-right: 1px solid black;">Test Communication</td> <td style="text-align: center;">Setup Communication Communication ID Numbers</td> </tr> </table>	WiFi Location <b>None</b>	Configure WiFi	Ethernet Information			GSM Information	Use the down ▼ arrow to scroll to the next page of options. Use the ▲ arrow to return to the previous page:			Communication Status	Test Communication	Setup Communication Communication ID Numbers
WiFi Location <b>None</b>	Configure WiFi	Ethernet Information											
		GSM Information											
Use the down ▼ arrow to scroll to the next page of options. Use the ▲ arrow to return to the previous page:													
Communication Status	Test Communication	Setup Communication Communication ID Numbers											

## Programming the Control

SCREEN	ACTION
<p>WiFi Location <b>None</b></p>	<p>2. Select "WiFi Location". The System will scroll between "None" and "Speaker Side". After selecting "Speaker Side", the "Configure WiFi" option will be displayed.</p> <p>3. Select "Configure WiFi". The following options will be displayed":</p> <p style="text-align: center;">Scan Access Points Manually Configure AP WPS*</p> <p style="text-align: right;">* If available</p>

### Enroll using Scan Access Points

**Note:** If the preferred access point is not available after scanning, manually select the network via the "Manually Configure Access Points" procedure.

1. Select "Scan Access Points". The available networks and signal strength are displayed. Use the down ▼ arrow to scroll to the next page of options. Use the ▲ arrow to return to the previous page.

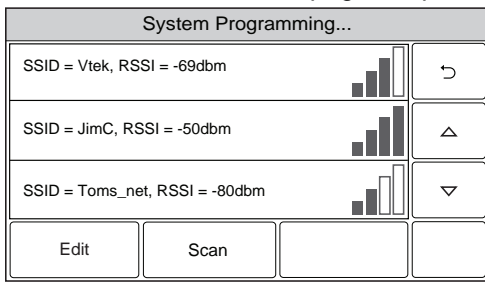

2. Select the desired Network and then press the "Edit" button. The network information is displayed. Select the "Join" button. A confirmation screen will be displayed.
3. Select "OK", then select "Save" to confirm the selection.
4. Select the "↶" button two times. The Ethernet information will be displayed. Signal strength will be indicated by a series of colored bars along with the RSSI level (in dBm).

Bars	Meaning	RSSI range (dBm)
4 White	No connection	-255 (used internally)
1 Yellow, 3 White	Weak	-81 or higher
2 Yellow, 2 White	Fair	-71 to -80
3 Yellow, 1 White	Good	-51 to -70
4 Yellow	Excellent	-50 or less

### Manually Configure Access Points

1. Select "Manually Configure AP", the following screen is displayed.

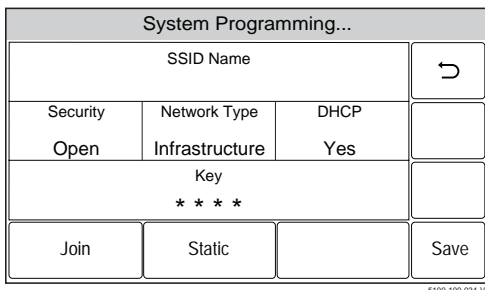

2. Select "SSID Name" and then enter a name (not to exceed 31 characters) on the displayed keyboard.
3. Select "Security". The system scrolls between the following options:  
Open  
WPA1  
WPA2  
WEP\*      When configuring for WEP encryption key on the access point, always use hexa-decimal type as the input method.
4. Select "Network Type". The system scrolls between "Infrastructure" and "Ad-Hoc".



## Programming the Control

5. Select "DHCP". The system scrolls between "Yes" and "No". If "No" is selected the "Static" button is displayed.  
**Note:** When entering a password, up to 31 characters can be entered. The system will only display the first 22 characters but will accept up to 31.
6. If a password is required, select "Key" and enter the password.
7. Select the "Static" button and go to step 8.
8. Select each of the following and enter the required information on the displayed keyboard:  
 IP Address (Enter the 4-part address)  
 Subnet Mask (Enter the 4-part address)  
 Gateway IP Address (Enter the 4-part address)  
 DNS Server IP Address (Enter the 4-part address)
9. Select "Save" when complete. Pressing "Save" will cause the panel to automatically attempt to join the configured access point every time the system is powered up.
10. Select "Join" when ready to connect with the access point. If the panel joins the access point successfully, it will automatically attempt to join this access point again on power up.

### WiFi Protected Set-up (WPS) (If available)

**Note:** For WPS operation, press the WPS button on the access point first. Then press the WPS button within 2 minutes

1. Select "WPS", the system displays "Please Stand-by for WPS Operation...".
2. If the operation is successful the system displays "Device has been successfully added to the network." Select "OK".
3. If the operation is unsuccessful the system displays "Failed Operation. Device not added to the network." Select "OK".

### Factory Defaults

This procedure resets the programming options to factory-default values.

SCREEN	ACTION
Comm. Diagnostics	1. Select "Comm. Diagnostics" The System displays the following options depending upon the communication device that is installed: <div style="display: flex; justify-content: space-around; border-bottom: 1px solid black; padding: 5px;"> <div style="text-align: center;">WiFi Location <b>None</b></div> <div style="text-align: center;">Configure WiFi</div> <div style="text-align: center;">Ethernet Information GSM Information</div> </div> Use the down ▼ arrow to scroll to the next page of options. Use the ▲ arrow to return to the previous page: <div style="display: flex; justify-content: space-around; padding: 5px;"> <div style="text-align: center;">Communication Status</div> <div style="text-align: center;">Test Communication</div> <div style="text-align: center;">Setup Communication Communication ID Numbers</div> </div>
Setup Communication	2. Select "Setup Communication". The System advances to the Registration screen and the following options are displayed: <div style="display: flex; justify-content: space-around; border-bottom: 1px solid black; padding: 5px;"> <div style="text-align: center;">Register Device Update Server</div> <div style="text-align: center;">Register Device With PIN Factory Defaults</div> </div> 3. Select "Factory Defaults" and select "Yes" when the confirmation screen appears. The device is reset to factory default values. Selecting "No" will cancel the operation. (Refer to the table below for applicable registration messages.)

The following messages may be displayed:

Message	Meaning
Default Configuration – Successful!	Indicates all programmed values are reset to the original factory settings.
Default Configuration Failed – Access Denied	Error message indicates the device does not have local programming access.
Default Configuration – Try Later!	Error message indicates the module is busy.

## **Remote Programming/Control (Downloading)**

### **General Information**

The control panel can be remotely programmed from an IBM-compatible Personal Computer (PC), Compass Downloader, a HAYES compatible Modem or via a capable GSM or IP Communications Module. When connected to the COMPASS Downloader – “SERVICE UPDATE” appears on touch screen.

---

**UL** Downloading may only be performed if a technician is at the site.

---

Multiple security levels protect remote programming against compromise by attempts to defeat the system.

- 1. Security Code Handshake:** A download ID code is verified for authenticity before connection is established.
- 2. Site-Initiated Remote Programming:** The installer initiates downloading by selecting the “Initiate Download” button on the Installer programming screen.
- 3. Station-Initiated Remote Programming:** The operator calls the site from your office to initiate the download call. The Control hangs up and then calls back the PC via the preprogrammed telephone number. The unit can then be uploaded, downloaded, or controlled from your office.
- 4. Data Encryption:** Data passed between the PC and the Control is encrypted for security so that it is very difficult for a foreign device tapped into the phone line to take over communication and substitute system-compromising information.

### **Equipment required to download to a system at the premises**

- Compass Downloader for Windows (at revision level supporting LYNX Touch).

**Flexible Callback:** If enabled in Installer Programming, the download operator can temporarily change the last 1, 2, or 3 digits (depending on selection) of the call back number. This allows the control to call back a computer other than the one programmed, which may be helpful at times of high computer traffic.

### **Remote Programming Information**



---

**If using Remote Programming, the LYNX Touch must be connected to the telephone line, GSM Cellular or to the Internet, as applicable.**

---

The downloading system can perform many functions when in communication with the Control. Besides uploading and downloading, the status of the system can be observed and various commands can be initiated, as follows:

- Arm the system in the away mode; disarm the system.
- Bypass a zone.
- Force the system to accept a new program download.
- Shut down communication functions (for nonpayment of monitoring fees in an owned system).
- Shut down all security system functions (for nonpayment for a leased system).
- Inhibit local keypad programming (prevents account takeover).
- Command the system to upload a copy of its resident program to the office.
- Set the time
- View/Modify
- Read: arming status, AC power status, lists of faulted zones, bypassed zones, zones currently in alarm, zones currently in trouble, and RF sensors with low battery conditions; read control’s time.

- Notes:**
- (1) After the control and the PC have established valid communication, “Service Update” will be displayed on the LCD.
  - (2) The detailed operation of the download functions is covered in the installation instructions for the Compass Downloader for Windows.

## **Remote Programming/Control (Downloading)**

### **Remote Programming Advisory Notes**

- A copy of the program downloaded may be printed using the IBM PC-compatible computer's internal report generator, when an optional printer is connected (consult your PC manual for proper printer and connections).
- The approximate time for program upload or download for a complete program is shown below:

<b>Communication Method</b>	<b>Approximate Time</b>
PSTN	380 secs.
GSM	75 secs.
IP or WiFi	30 secs.

## System Operation

### Key/Touchscreen Operation

The keys and touchscreen allows the user to arm and disarm the system, and perform other system functions, such as bypassing zones. Zone and system conditions (ALARM, trouble, bypass) are displayed on the display. When an alarm occurs, console sounding and external sounding will occur, and the zone(s) in alarm will be displayed on the display. Pressing any key will silence the keypad sounder for 10 seconds (only once). Disarming the system will silence both console and external sounders. When the system is disarmed, any zones that were in an alarm condition during the armed period will be displayed (memory of alarm). To clear this display, simply repeat the disarm sequence by pressing the OFF key and entering the Security Code. The console also features chime annunciation, and three panic key icons for silent, audible, fire or personal emergency alarms. These keys can notify the central station of an alarm condition, if that service is connected.

### Panic Key/Icons

There are three panic key icons that, if programmed, are displayed on the virtual keypad when the “PANIC” key is depressed for four seconds. The panic key screen will timeout if a selection is not made within ten seconds. The keys can be used to manually initiate alarms and send a report to the central station. Each can be individually programmed for 24-hour silent, audible, personal or fire emergency responses. The panic function is activated when the respective keys is pressed. The panic functions are identified by the system as follows:

Zone	Function
95	Fire Emergency
96	Medical Emergency
99	Police Emergency

**Important:** For the silent panic functions to be of practical value, the system must be connected to a central station.

### Security Codes

#### Installer Code

The installer programs the 4-digit Installer Code initially as part of the programming procedure. The factory default Installer Code is **4-1-1-2**, but may be changed in the Installer Code programming field. The Installer Code is the only code that allows entry into Installer Programming mode.

#### Master Code

In normal operation mode, the Master Code is used to enter the 4-digit User Security Codes.

#### Enter/Change the Master Code by installer.

The factory default Master Code for the LYNX Touch Control is set to 1-2-3-4. The Master Code is used to enter the 4-digit User Security Codes.

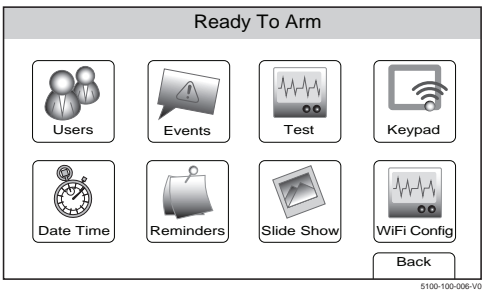
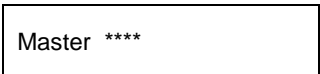
SCREEN	ACTION
	<ol style="list-style-type: none"> <li>1. After entering the User Tools/Programming Menu, select the “Users” icon on the User Menu screen. The system displays the User Code Programming screen</li> </ol>
	<ol style="list-style-type: none"> <li>2. Select “Master”, then select “Edit”.</li> <li>3. Enter a new four-digit Master Code on the displayed keypad The system will display the new code on the left side of the screen.</li> <li>4. Select “Done” when you are finished.</li> <li>5. The system returns to the User Code Programming screen.</li> </ol>

**Secondary User Codes**

In normal operation mode, the Master Security Code can be used to assign up to 14 secondary 4-digit security codes, including a Babysitter Code and a Duress Code. The Master Code can also be used to remove secondary codes from the system (individually). Refer to the LYNX Touch User Manual for additional information.

**Reset Master User Code**

1. After Entering the Installer Programming Mode, select “Reset Master Code” from the second page of the Installer Programming Tools menu.
2. The system displays a confirmation screen. Select the “Yes” key to reset the Master User Code to “1234”.
3. If confirmed, the Master Code will be reset back to “1-2-3-4”. This will be logged in the System Event Log as “Reset Master Code User 2 E655”. The system returns to the second page of the Installer Programming Tools menu. OR

If the reset failed, the system will display: “Command Failed. Unable to Reset Master Code”.

**Security Code Notes**

- The Master and Secondary security codes permit access to the system for arming, disarming, etc.
- The Installer Code can disarm the system only if it was used to arm it. In addition, the Installer Code cannot disarm the system if it was armed by pressing and holding a Quick-Arm button.
- The Babysitter Code can disarm the system only if it was used to arm it. In addition, the Babysitter Code cannot disarm the system if it was armed by pressing and holding a Quick-Arm button.
- Duress code sends a special code to the monitoring station when used to perform any system operation. Instruct users to be careful not to use this code for normal usage.
- Opening/closing reports are sent for the Installer Code, with the appropriate subscriber number. Master Code and set of secondary user codes are sent as Nos. 02 and 03–14, respectively, in Contact ID® format (with the appropriate user number).

## System Operation

### “Follow Me” System Announcement Feature

This feature allows the LYNX Touch to deliver a voice system message to the user phone numbers programmed by the installer. The LYNX Touch will first transmit reports to the Central Station and after receiving its kiss-off the system will dial the user phone numbers and begin transmitting the welcome message “System Message, Press Star to Play”. The system will dial the user phone numbers a maximum of eight times.

The “Follow Me” System announcements feature is only supported if PSTN line is available. The announcements are individually sent to the phone, numbers which are programmed as Phone 1 and Phone 2 respectively in the Reporter Programming section. System Follow Me announcements are triggered by a system event that belongs to one of the Event Groups enabled by Installer individually for the programmed phone number(s). The groups are listed below.

- All Bypassing actions by a user
- Any Open/Close (arming/disarming status changes)
- Any Alarms
- Any Alarm Restores
- Alarm Cancel by the user
- Any System Troubles
- Any Test
- Non-security Events

If a “\*” key is not pressed, LYNX Touch will announce “System message Press \* to Play” for 45 seconds before hanging up and redialing the programmed number. The control will make eight attempts before unsuccessfully ending the System “Follow Me” session and erasing all the events in the queue. The next call will be triggered by a new event from the Event Group enabled for the programmed number(s).

If a “\*” key is pressed, LYNX Touch will play back a sequence of System “Follow Me” announcements from the queue in chronological order starting with the oldest one. The announcements will include “End of Message” at the end of the “Follow Me” announcements.

If a “\*” key is pressed again during playback or within 15 seconds following the end of the playback, the control will repeat the sequence. Otherwise the system will hang up, successfully ending the System “Follow Me” session. Because the “\*” key was pressed LYNX Touch will not redial the number again. The next call will be triggered by a new event from the Event Group enabled for the programmed number(s).

**Note:** The follow me system announcement will be terminated if any other event requires the system to send a report to the Central Station. Once the PSTN line is available the session will be resumed and the control will again make up to 8 delivery attempts.

Follow Me Event Triggers	Follow Me Announcement
AC Loss	AC Loss
Audible Panic	Panic Alarm
Automatic Disarmed	Disarmed
Battery Failed Under Load	System Low Battery
Burglary Zone Bypass	Zone ** Bypassed
Carbon Monoxide Detected	Carbon Monoxide Alarm
Disarmed From AWAY or STAY	Disarmed
Emergency Alarm	Emergency Alarm
Entry/Exit Alarm	Perimeter Alarm
Exit Error Alarm (zone)	Perimeter Alarm
Expansion Module Tamper	Tamper Alarm
Expansion Module Failure	System Trouble
Expansion Module Tamper Alarm	Tamper Alarm
Expansion Module Tamper Trouble	Tamper Alarm
Fire Alarm	Fire Alarm
Fire Trouble	System Trouble

Follow Me Event Triggers	Follow Me Announcement
Interior Alarm	Interior Alarm
Keypad Panic	Panic Alarm
Manual Test	System Test
Medical Alarm	Emergency Alarm
Perimeter Alarm	Perimeter Alarm
Remote Disarm	Disarmed
RF Sensor Lost	System Trouble
Sensor Low Battery or Tamper	Sensor Trouble
Silent Burglary	Silent Burglary
Siren Tamper	Tamper Alarm
System Inactivity	No Check In
System Low Battery	System Low Battery
Water Leakage Alarm	Auxiliary Alarm
Zone Bypass	Zone ** Bypassed
Zone Tamper (Alarm)	Tamper Alarm
Zone Trouble	System Trouble

\*\* = Zone Number

### **“Follow Me” Reminder Feature**

This feature allows the user to schedule a time driven message. When activated, the system will dial the User 1 and/or User 2 phone numbers, which are programmed as Phone 1 and Phone 2 respectively by the installer (in the Reporter Programming section), and deliver a recorded message. The LYNX Touch will immediately begin transmitting the voice message and will repeat the message for 45 seconds. If the message has timed out, the system will redial the programmed number a maximum of seven additional times or until it is acknowledged. Pressing any key on the LYNX Touch keypad will terminate both the “Follow Me” reminder and the local reminder announcements.

- Notes:**
- (1) This feature is only supported if it has been programmed.
  - (2) The follow me reminder will be terminated if any other event requires the system to dial out, however, delivery of the local schedule reminder message will continue.
  - (3) If a Central Station report must be sent, the “Follow Me” Reminder message will be suspended. Once the PSTN line is available the session will be resumed and the control will again make up to 8 delivery attempts.

### **Remote Phone Control Feature**

The remote phone control feature, which must be enabled, allows the user to access the security system from any off-site touch-tone telephone. The control will pick up the incoming call, based on the specified ring count, and will announce “SYSTEM ENTER CODE” every three seconds for the next nine seconds. During this period the panel will wait for a valid User Code to be entered. If a valid User Code is not entered or the nine second period expires a modem tone will be generated for remote programming (Compass Downloading). If a valid User Code has been entered, the control will announce the current system status and/or beeping sounds. Refer to the User Guide for additional information regarding this feature.

## System Operation

### System Displays

The following icons will be displayed on the Home screen along with specific zone status information (if applicable) to indicate system status.

DISPLAY	DEFINITION
	AC Loss
	Alarm (intrusion)
	Armed Away
	Armed Stay
	Battery Low
	Check Zones
	CO Alarm
	Disarmed Not Ready to Arm
	Disarmed Ready to Arm
	90 RF Jam
	94 Phone Line Cut
	103 Comm. Trouble

DISPLAY	DEFINITION
	Door Open
	Window Open
	Exit Active
	Fire OR Heat Sensor
	Flood
	Glass Break
	Medical Alarm
	Motion
	Temperature
	Cover Tamper
	Reporter Failure
	Automation (Z-Wave Node Failure)

### Zone Status Displays

The following icons will be displayed on the Zone Status screen along with specific zone status information when a zone has been Faulted, Bypassed or in Alarm.

DISPLAY	DEFINITION
	Alarm
	Fault (Yellow)

DISPLAY	DEFINITION
	Ready
	Trouble (red)

DISPLAY	DEFINITION
	Bypass



**UL** Audio alarm verification has not been evaluated by UL.

**Audio Alarm Verification (Two-Way Voice Feature)**

This feature allows the central station operator to listen, talk to or conduct a two-way conversation with an individual(s) at the premises. It also assists the operator in gathering information about the nature and location of the alarm that may be helpful in responding to police and fire departments. All LYNX Touch control panels are capable of supporting the Two-Way Voice feature. The LYNX Touch does not make system announcements when the Two-Way voice feature is active.

**Activation**



**Fire and CO alarms will prevent the LYNX Touch from starting an AAV session. A new Fire or CO alarm will end an AAV session that is in progress.**

The LYNX Touch sends the “alarm message” followed by a “Listen-in-to-Follow message” (Contact ID® code 606) to the Central Station. The Listen-in-to-Follow message causes the Central Station’s digital receiver to temporarily hold the phone line for approximately 1-minute. When the LYNX Touch receives the “kissoff” from the central station, indicating that the alarm message has been received, the Two-Way Voice (AAV) feature is activated in the (default) “Listen Mode” and sirens and keypad sounds are discontinued. The LYNX Touch transmits a beep acknowledgment to the Central Station, once per second. The beep alternates between two tones and indicates that the LYNX Touch is waiting for a session command from the Central Station operator. Once a command is issued the beep acknowledgement is discontinued, however, if a command is not issued within two minutes the system will “time out” and the call will be terminated.

**Operator Commands**

The Central Station operator begins the session, which last 5 minutes, by entering one of the valid AAV commands shown in the table below. The session may be extended 5 minutes, without changing the operating mode, by pressing the [7] key on the touch-tone phone. Selecting another operating mode also resets the session an additional 5 minutes. During the last minute of the 5 minute, session, the LYNX Touch generates two beeps every 30 seconds to alert the Central Station operator that the session is about to time out. The Central Station operator may then extend the session by pressing the [7] key on the touch-tone phone. If the session is not extended the phone line is disconnected, and the session is ended. Sessions may be ended at any time by pressing the [9] key on the touch-tone phone. The AAV modes are described as follows:

**Note:** When entering AAV commands make sure the Central Station receiver has been disconnected from the phone line, otherwise AAV commands may not go through.

Key	Function
1	Talk Mode: Pressing the [1] key on the touch tone phone, enables one-way voice communication from the central station to the violated premises, and allows the operator to talk communicate through the LYNX Touch speaker. In this mode the Red (Armed) and Green (Ready) LEDs blink alternately.
2	VOX (Voice) Mode: Pressing the [2] key on the touch-tone phone, enables two-way voice communications between the central station and the violated premises. In this mode the Red (Armed) and Green (Ready) LEDs blink alternately.
3	Listen Mode: Pressing the [3] key on the touch-tone phone, enables one-way audio from the violated premises to the central station. The Listen Mode is the start up default mode of the voice feature and allows the operator to listen through the LYNX Touch microphone. This mode does not affect the existing LED pattern.
7	Extends the session 5 minutes without changing its operating mode.
9	Ends the session and disconnects the phone line.

## System Operation

### Event Log

The LYNX Touch Series event log is capable of recording and displaying up to 128 system events. The type of events that can be recorded is selectable and is programmed in the System Type programming field. The event log can be reviewed by entering the Installer Programming or Master User Programming mode. Refer to the LYNX Touch Series User Manual for additional information.

**Note:** In the unlikely condition that the backup battery becomes fully discharged when AC power is lost, any system activity performed after the low battery notification will not be saved in the event log. Additionally, the panel will revert to the status condition as before the low battery notification.

### Contact ID® & SIA Event Log Codes

CID Code	Definition	SIA Code	Definition
110	Alarm, Fire	AT/AR	AC Trouble/AC Restoral
121	Alarm, Duress	BA/BR	Burglary Alarm/Burglary Restoral
122	Alarm, Silent	BB/BU	Burglary Bypass/Burglary Unbypass
123	Alarm, Audible	CA/CD	Automatic Closing/Closing Delinquent
131	Alarm, Perimeter	CI	Fail to Close
132	Alarm, Interior	CL	Closing Report
134	Alarm, Entry/Exit	CQ	Remote Closing
135	Alarm, Day/Night	CR	Recent Closing
137	Alarm, Tamper	DF/DR	Door Forced/Door Restoral
145	Expansion Module Tamper	EA	Exit Alarm
146	Silent Burglary	EM/EN	Expansion Device Missing/Expansion Missing Restore
150	24-Hour Non-Burglary	ES/EJ	Expansion Device Tamper/Expansion Tamper Restore
162	Carbon Monoxide Detected	ET	Expansion Trouble
301	Trouble, AC Loss	FA	Fire Alarm
302	Trouble, Low System Battery	FT/FJ	Fire Trouble/Fire Trouble Restore
305	Trouble, System Reset	HA/HR	Holdup Alarm/Holdup Restoral
316	System Tamper*	JL	Log Threshold
341	Trouble, Case Tamper	LB/LX	Local Progr./Local Progr. End (Logged in Event Log )
344	Trouble, RF Receiver Jam Detect	LT/LR	Phone Line Trouble/Phone Line Restoral
351	Trouble, Telco 1 Fault	MA/MR	Medical Alarm/ Medical Restoral
353	Trouble, Long Range Radio Transmitter Fault	OA	Automatic Opening
373	Trouble, Fire Trouble	OC	Cancel Report
374	Trouble, Exit Error Alarm	OP	Opening Report
380	Trouble, Sensor	OQ	Remote Opening
381	Trouble, Loss of Supervision RF	PA	Panic Alarm
383	Trouble, Sensor Tamper	RP	Automatic Test
384	RF Low Battery	RS	Remote Program Success
401	Open/Close by User	RX	Manual Test
403	Open/Close Automatic	TA/TH	Tamper Alarm/Tamper Alarm Restore
406	Cancel	TJ	Tamper Trouble Restore
407	Remote Arm/Disarm	TS/TE	Test Start/Test End
408	Quick Arm	TT	Tamper Trouble
441	Armed Stay	UA	Untyped Zone Alarm
455	Auto-Arm Failed	UB/UU	Untyped Zone Bypass/Untyped Zone Unbypass
459	Recent Close	WA/WR	Water Alarm/Water Restoral
570	Zone/Sensor Bypass	XG/XH	RF Interference/RF Interference Restore
601	Manual Trigger Test Report	XT/XR	Transmitter Battery Trouble/Transmitter Battery Restoral
602	Periodic Test Report	YC/YK	Communications Fail/Communications Restoral
606	Listen-in to follow	YM	System Battery Missing
607	Walk Test	YT/YR	System Battery Trouble/System Battery Restoral
623	Event 90% Full		
627	Program Mode Entry (Logged in Event Log Only)		
628	Program Mode Exit (Logged in Event Log Only)		
654	System Inactivity		
655	Reset Master Code (Logged in Event Log Only)		
759	Resident Monitor Zone Response		
760	Resident Response Zone Response		
761	General Monitor Zone Response		
762	General Response Zone Response		

\*If APL is enabled, AlarmNet will generate a special comm. fail message (E316) if it does not hear from a unit within 15 minutes after a delayed alarm is delivered. This message is meant to alert the Central Station that the system has been tampered with and may have been compromised.

## Testing the System

### TO THE INSTALLER

Regular maintenance and inspection (at least annually) by the installer and frequent testing by the user are vital to continuous satisfactory operation of any alarm system.

The installer should assume the responsibility of developing and offering a regular maintenance program to the user as well as acquainting the user with the proper operation and limitations of the alarm system and its component parts. Recommendations must be included for a specific program of frequent testing (at least weekly) to ensure the system's proper operation at all times.

### Test Modes

The "Test" button provides access to the following functions and test modes:

Option	Function
Walk Test	Refer to the User Manual for additional information
RF Sniffer Test	Refer to the <i>Installing Wireless Zones</i> section of this manual for additional information.
Go-No-Go Test	Refer to the <i>Installing Wireless Zones</i> section of this manual for additional information.
Dialer Test	Refer to the to the paragraph in this section and the User Manual for additional information
Zone Discovery	Provides access to the Zone Discovery. Refer to the paragraph in this section for additional information regarding the Zone Discovery feature.
Diagnostics	Provides access to the Reboot Feature. Refer to the paragraph in this section for additional information regarding the Reboot feature.

### Testing the System

After installation is completed, the security system should be carefully tested, as follows:

1. With the system in the disarmed state, check that all zones are intact. If the "ready" LED is not lit, select the Zones icon to display the faulted zone(s). If necessary, restore faulted zone(s) so that the "ready" LED lights. Fault and restore every sensor individually to assure that it is being monitored by the system.

### Armed System Test

Alarm messages will be sent to the central station during the following tests 1 and 2. **Notify the Central Station in advance that tests will be in progress.**

1. Arm the system and fault one or more zones. After 15 seconds (if optional dialer delay is selected), silence alarm sounder(s) by pressing OFF and entering the security code. Check entry/exit delay zones.
2. Check the keypad-initiated alarms that are in the system by selecting the Panic key. If the system has been programmed for audible emergency, the keypad will emit a steady alarm sound, and "ALARM" and zone number will be displayed. For LYNX Touch, silence the alarm pressing OFF and entering the Security Code. For LYNX Touch SIA configuration, silence the alarm by entering the Security Code.

If the system has been programmed for silent emergency, there will be no audible alarms or displays, but a report will be sent to the central station.

3. Notify the central station when all tests are finished, and verify results with them.
4. To test the wireless part of the system and the RF receiver, perform the two additional tests described in the *Installing Wireless Zones* section: Sniffer mode and Go/No Go Test.

**Note:** System Test mode and Go/No Go Test will be automatically terminated after 3-1/2 to 4 hours if the installer or user does not manually terminate it. This ensures that fire and panic zones will not remain disabled. However, Sniffer mode does not automatically expire. You must manually exit (by entering an OFF Sequence) Sniffer mode to return to normal operation. During the final 5 minutes the system will emit double beeps indicating that the end of Test mode is nearing.

### Dialer Test

The Dialer Test checks that the phone connection to the central station is working properly. **Notify the Central Station in advance that tests will be in progress.**

1. With the System in the Installer Programming mode, select the "Test" button and then select the "Dialer Test" button.

## **Testing the System**

2. If the test is successful the system will send the Manual Trigger Test Report (E601) to the Central Station. The test will not be recorded in the Event Log.
3. The system will make 8 attempts to test the dialer for both the Primary and Secondary Central Station, as applicable. If the test is unsuccessful the system will display a “Reporter Failure” trouble message after 1-17 minutes.

## **Zone Discovery Mode**



**Zone Discovery mode requires Installer supervision when in use. The system is not fully operational for fire or life safety while Zone Discovery Mode is active.**

Zone discovery mode can be used to remotely view all zones that have been programmed in the system for operation. The zones must have a response type programmed and in the case of RF zones, must also have a serial number programmed. All zones programmed (except for duress) will be displayed.

### **Enter Zone Discovery**

1. With the System in the Installer Programming mode, select the “Test” button and then select the “Zone Discovery” button. The “Zone Discovery” button will be highlighted indicating that the mode is active.

### **Exit Zone Discovery**

1. Enter an Off sequence. If you do not exit zone discovery mode manually, the system will automatically exit zone discovery mode in approximately 1-4 minutes dependent upon the number of zones that are programmed. The system beeps once and returns to the home screen.

## **Rebooting the System**

The Reboot function allows you to restart the system if required. To reboot the system perform the following:

1. With the System in the Installer Programming mode, select the “Test” button and then select the “Diagnostics” button.
2. The system advances to the next screen. Select the “Reboot” button. A confirmation screen will appear.
3. Select “Yes”. The system will restart.

**Note:** After the reboot sequence is complete it is recommended that you perform a “Walk Test” to verify that all transmitters are operational in the system.

**LYNX Touch Programming Default Tables**

Program Function	Table 1	Table 2	Table 3	Table 4
<b>Installer Code</b>	4112	4112	4112	4112
<b>System Type</b>				
RF Jam	Disabled	Disabled	Disabled	Disabled
Speaker Phone	Enabled	Enabled	Enabled	Enabled
Two Way Voice	Disabled	Disabled	Disabled	Disabled
RF House Code	0	0	0	0
Phone Notification	Disabled	Disabled	Disabled	Disabled
Remote Phone	Enabled	Enabled	Enabled	Enabled
Phone Detect Time	2 Minutes	2 Minutes	2 Minutes	2 Minutes
Events - Log All	Press To Log All	Log All Set	Press To Log All	Press To Log All
Events - Log Alarm	Enabled	Enabled	Enabled	Enabled
Events - Log Bypass	Disabled	Enabled	Disabled	Disabled
Events - Log Open/Close	Disabled	Enabled	Disabled	Disabled
Events - Log Trouble	Enabled	Enabled	Enabled	Enabled
Non Security	Disabled	Enabled	Disabled	Disabled
Remote Access Serial	Disabled	Disabled	Disabled	Disabled
Multi Mode Serial	Disabled	Disabled	Disabled	Disabled
<b>Date Time</b>				
Calendar	January 1, 2011	January 1, 2011	January 1, 2011	January 1, 2011
Enter Time	10:00AM	10:00AM	10:00AM	10:00AM
Time Zone	Eastern (EST)	Eastern (EST)	Eastern (EST)	Eastern (EST)
Day Light Savings time	Yes	Yes	Yes	Yes
Start Month	March	March	March	March
Start Week	Second	Second	Second	Second
End Month	November	November	November	November
End Week	First	First	First	First
<b>Communicator</b>				
Communications Path	None	None	None	None
APL	Disabled	Disabled	Disabled	Disabled
City ID	None	None	None	None
CS ID	None	None	None	None
Sub ID	None	None	None	None
Supervision	24 Hours	24 Hours	24 Hours	24 Hours
Old Alarm Time	10 Minutes	10 Minutes	10 Minutes	10 Minutes
Remote Acc. Comm.	Disabled	Disabled	Disabled	Disabled
Multi Mode Comm.	Disabled	Disabled	Disabled	Disabled
GSM Fault Time	00	00	00	00
IP Fault Time	00	00	00	00
Use DHCP	Yes	Yes	Yes	Yes
NI IP Address	255.255.255.255	255.255.255.255	255.255.255.255	255.255.255.255
Subnet Mask	255.255.255.255	255.255.255.255	255.255.255.255	255.255.255.255
Gateway IP Address	255.255.255.255	255.255.255.255	255.255.255.255	255.255.255.255
DNS Server IP Address	255.255.255.255	255.255.255.255	255.255.255.255	255.255.255.255
<b>Zones</b>	See Zone Programming Default Tables			
<b>Reporter</b>				
Primary CS Info				
Phone Type	Contact Id: 4 Digit	Contact Id: 4 Digit	Contact Id: 4 Digit	Contact Id: 4 Digit
Communicator Type	None	None	None	None
Phone Number	Blank	Blank	Blank	Blank
Account Number	FFFF	FFFF	FFFF	FFFF
Dynamic Priority	None	None	None	None
Dynamic Delay	None	None	None	None
Report All	Press to Report All	Press to Report All	Press to Report All	Press to Report All
Report Alarms	Enabled	Enabled	Enabled	Enabled
Report Troubles	Enabled	Enabled	Enabled	Enabled
Report Open/Close	Disabled	Disabled	Disabled	Disabled
Report Tests	Enabled	Enabled	Enabled	Enabled

**LYNX Touch Programming Default Tables**

Program Function	Table 1	Table 2	Table 3	Table 4
<b>Secondary CS Info</b>				
Phone Type	None	None	None	None
Communicator Type	None	None	None	None
Phone Number	Blank	Blank	Blank	Blank
Account Number	FFFF	FFFF	FFFF	FFFF
Dynamic Priority	None	None	None	None
Dynamic Delay	None	None	None	None
Report All	Press to Report All	Press to Report All	Press to Report All	Press to Report All
Report Alarms	Enabled	Enabled	Enabled	Enabled
Report Troubles	Enabled	Enabled	Enabled	Enabled
Report Open/Close	Disabled	Disabled	Disabled	Disabled
Report Tests	Enabled	Enabled	Enabled	Enabled
<b>Follow Me Phone 1</b>				
Phone Type	None	None	None	None
Phone Number	Blank	Blank	Blank	Blank
Report All	Press To Report All	Press To Report All	Press To Report All	Press To Report All
Report Alarms	Disabled	Disabled	Disabled	Disabled
Report Troubles	Disabled	Disabled	Disabled	Disabled
Report Open/Close	Disabled	Disabled	Disabled	Disabled
Report Tests	Disabled	Disabled	Disabled	Disabled
<b>Follow Me Phone 2</b>				
Phone Type	None	None	None	None
Phone Number	Blank	Blank	Blank	Blank
Report All	Press To Report All	Press To Report All	Press To Report All	Press To Report All
Report Alarms	Disabled	Disabled	Disabled	Disabled
Report Troubles	Disabled	Disabled	Disabled	Disabled
Report Open/Close	Disabled	Disabled	Disabled	Disabled
Report Tests	Disabled	Disabled	Disabled	Disabled
<b>Report Selection</b>				
Arm Away	Enabled	Enabled	Enabled	Enabled
Arm Stay	Enabled	Enabled	Enabled	Enabled
Disarm	Enabled	Enabled	Enabled	Enabled
Exit Error	Enabled	Disabled	Enabled	Enabled
Recent Closing	Enabled	Enabled	Enabled	Enabled
Event Log Full	Enabled	Enabled	Enabled	Enabled
Trouble	Enabled	Enabled	Enabled	Enabled
Trouble Restore	Enabled	Enabled	Enabled	Enabled
Alarm Restore	Enabled	Enabled	Enabled	Enabled
Alarm Cancel	Enabled	Enabled	Enabled	Enabled
Test	Enabled	Enabled	Enabled	Enabled
Test Restore	Enabled	Enabled	Disabled	Enabled
Bypass	Enabled	Enabled	Enabled	Enabled
Bypass Restore	Enabled	Enabled	Enabled	Enabled
AC Loss	Enabled	Enabled	Enabled	Enabled
AC Loss Restore	Enabled	Enabled	Enabled	Enabled
Low Battery	Enabled	Enabled	Enabled	Enabled
Low Battery Restore	Enabled	Enabled	Enabled	Enabled
RF Low Battery	Enabled	Enabled	Enabled	Enabled
RF Low Battery Restore	Enabled	Enabled	Enabled	Enabled
<b>Options</b>				
PBX	Blank	Blank	Blank	Blank
Call Wait Cancel	Blank	Blank	Blank	Blank
Number of Reports	Unlimited	Unlimited	Unlimited	Unlimited
Alarm Report Delay	No Delay	15 Seconds	No Delay	No Delay
First Report Offset	6 Hrs	12 Hrs	12 Hrs	12 Hrs
Report Frequency	Never	30 Days	Never	Never

**LYNX Touch Programming Default Tables**

Program Function	Table 1	Table 2	Table 3	Table 4
<b>Downloader</b>				
Phone Answer	Yes	Yes	Yes	Yes
Ans. Machine Defeat	Yes	Yes	Yes	Yes
Modem Speed (Future Use)	Slow	Slow	Slow	Slow
Ring Counter	2	2	2	2
Callback Number	Blank	Blank	Blank	Blank
Flexible Callback Number	No	No	No	No
	1	1	1	1
<b>Sounder</b>				
Burglary Alarm Sound	Yes	Yes	Yes	Yes
Burglary Bell Timeout	4 Minutes	4 Minutes	4 Minutes	4 Minutes
Fire Bell Timeout	4 Minutes	4 Minutes	4 Minutes	4 Minutes
Arm Confirm	None	None	None	None
Alarm Options	Unlimited	2	2	2
<b>System Settings</b>				
Entry Delay 1	30 Seconds	45 Seconds	30 Seconds	30 Seconds
Entry Delay 2	60 Seconds	60 Seconds	60 Seconds	60 Seconds
Exit Delay	60 Seconds	60 Seconds	60 Seconds	60 Seconds
Backlight Timeout	No	No	No	No
Quick Arm	Yes	Yes	Yes	Yes
Quick Exit	Yes	Yes	Yes	Yes
Restart Exit Time	No	Yes	Yes	Yes
Force Bypass	No	No	No	No
Exit Warning	No	Yes	Yes	Yes
Auto Stay Arming	No	Yes	Yes	Yes
Lack Of Usage Notify	Disabled	Disabled	Disabled	Disabled
Power-Up In Previous	Yes	Yes	Yes	Yes
Display Alarm Cancel	No	Yes	Yes	Yes
Display Exit Time	Yes	Yes	Yes	Yes
Cross Zone Delay	3 Minutes	None	None	None
Cross Zone 1	Disabled	Disabled	Disabled	Disabled
Cross Zone 2	Disabled	Disabled	Disabled	Disabled
<b>Z-Wave</b>				
Z-Wave	Enabled-Installed	Enabled-Installed	Enabled-Installed	Enabled-Installed
Temperature	Fahrenheit	Fahrenheit	Fahrenheit	Fahrenheit

**LYNX Touch SIA Programming Default Tables**

Program Function	Table 1	Table 2	Table 3	Table 4
<b>Installer Code</b>	4112	4112	4112	4112
<b>System Type</b>				
RF Jam	Disabled	Disabled	Disabled	Disabled
Speaker Phone	Enabled	Enabled	Enabled	Enabled
Two Way Voice	Disabled	Disabled	Disabled	Disabled
RF House Code	0	0	0	0
Phone Notification	Disabled	Disabled	Disabled	Disabled
Remote Phone	Enabled	Enabled	Enabled	Enabled
Phone Detect Time	2 Minutes	2 Minutes	2 Minutes	2 Minutes
Events - Log All	Press To Log All	Log All Set	Press To Log All	Press To Log All
Events - Log Alarm	Enabled	Enabled	Enabled	Enabled
Events - Log Bypass	Disabled	Enabled	Disabled	Disabled
Events - Log Open/Close	Disabled	Enabled	Disabled	Disabled
Events - Log Trouble	Enabled	Enabled	Enabled	Enabled
Non Security	Disabled	Enabled	Disabled	Disabled
Remote Access Serial	Disabled	Disabled	Disabled	Disabled
Multi Mode Serial	Disabled	Disabled	Disabled	Disabled
<b>Date Time</b>				
Calendar	January 1, 2011	January 1, 2011	January 1, 2011	January 1, 2011
Enter Time	10:00AM	10:00AM	10:00AM	10:00AM
Time Zone	Eastern (EST)	Eastern (EST)	Eastern (EST)	Eastern (EST)
Day Light Savings time	Yes	Yes	Yes	Yes
Start Month	March	March	March	March
Start Week	Second	Second	Second	Second
End Month	November	November	November	November
End Week	First	First	First	First
<b>Communicator</b>				
Communications Path	None	None	None	None
APL	Disabled	Disabled	Disabled	Disabled
City ID	None	None	None	None
CS ID	None	None	None	None
Sub ID	None	None	None	None
Supervision	24 Hours	24 Hours	24 Hours	24 Hours
Old Alarm Time	10 Minutes	10 Minutes	10 Minutes	10 Minutes
Remote Acc. Comm.	Disabled	Disabled	Disabled	Disabled
Multi Mode Comm.	Disabled	Disabled	Disabled	Disabled
GSM Fault Time	00	00	00	00
IP Fault Time	00	00	00	00
Use DHCP	Yes	Yes	Yes	Yes
NI IP Address	255.255.255.255	255.255.255.255	255.255.255.255	255.255.255.255
Subnet Mask	255.255.255.255	255.255.255.255	255.255.255.255	255.255.255.255
Gateway IP Address	255.255.255.255	255.255.255.255	255.255.255.255	255.255.255.255
DNS Server IP Address	255.255.255.255	255.255.255.255	255.255.255.255	255.255.255.255
<b>Zones</b>	See Zone Programming Default Tables			
<b>Reporter</b>				
Primary CS info				
Phone Type	Contact Id: 4 Digit	Contact Id: 4 Digit	Contact Id: 4 Digit	Contact Id: 4 Digit
Communicator Type	None	None	None	None
Phone Number	Blank	Blank	Blank	Blank
Account Number	FFFF	FFFF	FFFF	FFFF
Dynamic Priority	None	None	None	None
Dynamic Delay	None	None	None	None
Report All	Press to Report All	Press to Report All	Press to Report All	Press to Report All
Report Alarms	Enabled	Enabled	Enabled	Enabled
Report Troubles	Enabled	Enabled	Enabled	Enabled
Report Open/Close	Disabled	Disabled	Disabled	Disabled
Report Tests	Enabled	Enabled	Enabled	Enabled



**LYNX Touch SIA Programming Default Tables**

Program Function	Table 1	Table 2	Table 3	Table 4
Secondary CS info				
Phone Type	None	None	None	None
Communicator Type	None	None	None	None
Phone Number	Blank	Blank	Blank	Blank
Account Number	FFFF	FFFF	FFFF	FFFF
Dynamic Priority	None	None	None	None
Dynamic Delay	None	None	None	None
Report All	Press to Report All	Press to Report All	Press to Report All	Press to Report All
Report Alarms	Enabled	Enabled	Enabled	Enabled
Report Troubles	Enabled	Enabled	Enabled	Enabled
Report Open/Close	Disabled	Disabled	Disabled	Disabled
Report Tests	Enabled	Enabled	Enabled	Enabled
Follow Me Phone 1				
Phone Type	None	None	None	None
Phone Number	Blank	Blank	Blank	Blank
Report All	Press To Report All	Press To Report All	Press To Report All	Press To Report All
Report Alarms	Disabled	Disabled	Disabled	Disabled
Report Troubles	Disabled	Disabled	Disabled	Disabled
Report Open/Close	Disabled	Disabled	Disabled	Disabled
Report Tests	Disabled	Disabled	Disabled	Disabled
Follow Me Phone 2				
Phone Type	None	None	None	None
Phone Number	Blank	Blank	Blank	Blank
Report All	Press To Report All	Press To Report All	Press To Report All	Press To Report All
Report Alarms	Disabled	Disabled	Disabled	Disabled
Report Troubles	Disabled	Disabled	Disabled	Disabled
Report Open/Close	Disabled	Disabled	Disabled	Disabled
Report Tests	Disabled	Disabled	Disabled	Disabled
Report Selection				
Arm Away	Enabled	Enabled	Enabled	Enabled
Arm Stay	Enabled	Enabled	Enabled	Enabled
Disarm	Enabled	Enabled	Enabled	Enabled
Exit Error	Enabled	Enabled	Enabled	Enabled
Recent Closing	Enabled	Enabled	Enabled	Enabled
Event Log Full	Enabled	Enabled	Enabled	Enabled
Trouble	Enabled	Enabled	Enabled	Enabled
Trouble Restore	Enabled	Enabled	Enabled	Enabled
Alarm Restore	Enabled	Enabled	Enabled	Enabled
Alarm Cancel	Enabled	Enabled	Enabled	Enabled
Test	Enabled	Enabled	Enabled	Enabled
Test Restore	Enabled	Enabled	Enabled	Enabled
Bypass	Enabled	Enabled	Enabled	Enabled
Bypass Restore	Enabled	Enabled	Enabled	Enabled
AC Loss	Enabled	Enabled	Enabled	Enabled
AC Loss Restore	Enabled	Enabled	Enabled	Enabled
Low Battery	Enabled	Enabled	Enabled	Enabled
Low Battery Restore	Enabled	Enabled	Enabled	Enabled
RF Low Battery	Enabled	Enabled	Enabled	Enabled
RF Low Battery Restore	Enabled	Enabled	Enabled	Enabled
Options				
PBX	Blank	Blank	Blank	Blank
Call Wait Cancel	Blank	Blank	Blank	Blank
Number of Reports	2 Reports	2 Reports	2 Reports	2 Reports
Alarm Report Delay	30 Seconds	30 Seconds	30 Seconds	30 Seconds
First Report Offset	6 Hrs	12 Hrs	12 Hrs	12 Hrs
Report Frequency	Never	30 Days	Never	Never

**LYNX Touch SIA Programming Default Tables**

Program Function	Table 1	Table 2	Table 3	Table 4
<b>Downloader</b>				
Phone Answer	Yes	Yes	Yes	Yes
Ans. Machine Defeat	Yes	Yes	Yes	Yes
Modem Speed (Future Use)	Slow	Slow	Slow	Slow
Ring Counter	2	2	2	2
Callback Number	Blank	Blank	Blank	Blank
Flexible Callback	No	No	No	No
Number	1	1	1	1
<b>Sounder</b>				
Burglary Alarm Sound	Yes	Yes	Yes	Yes
Burglary Bell Timeout	4 Minutes	4 Minutes	4 Minutes	4 Minutes
Fire Bell Timeout	4 Minutes	4 Minutes	4 Minutes	4 Minutes
Arm Confirm	None	None	None	None
<b>System Settings</b>				
Entry Delay 1	30 Seconds	30 Seconds	30 Seconds	30 Seconds
Entry Delay 2	30 Seconds	30 Seconds	30 Seconds	30 Seconds
Exit Delay	60 Seconds	60 Seconds	60 Seconds	60 Seconds
Backlight Timeout	No	No	No	No
Quick Arm	Yes	Yes	Yes	Yes
Quick Exit	Yes	Yes	Yes	Yes
Restart Exit Time	Yes	Yes	Yes	Yes
Force Bypass	No	No	No	No
Exit Warning	Yes	Yes	Yes	Yes
Auto Stay Arming	Yes	Yes	Yes	Yes
Lack Of Usage Notify	Disabled	Disabled	Disabled	Disabled
Power-Up In Previous	Yes	Yes	Yes	Yes
Display Alarm Cancel	Yes	Yes	Yes	Yes
Display Exit Time	Yes	Yes	Yes	Yes
Cross Zone Delay	None	None	None	None
Cross Zone 1	Disabled	Disabled	Disabled	Disabled
Cross Zone 2	Disabled	Disabled	Disabled	Disabled
<b>Z-Wave</b>				
Z-Wave	Enabled-Installed	Enabled-Installed	Enabled-Installed	Enabled-Installed
Temperature	Fahrenheit	Fahrenheit	Fahrenheit	Fahrenheit

**Zone Programming Default Tables**

**Zone Assignment/Alarm Report Codes for Table 1**

Zone Number	Loop Number	Device Type	Response Type	Report	Chime	Supervision/ Input Type	Zone Descriptor
1	---	New	n/a	yes	no	EOLR	n/a
2	2	Door	Entry Exit 1	yes	yes	RF Supervised	Front Door
3	2	Door	Entry Exit 1	yes	yes	RF Supervised	Back Door
4	2	Window	Perimeter	yes	yes	RF Supervised	n/a
5	1	Motion Sensor	Interior w/Delay	yes	no	RF Supervised	n/a
49	3	4 Button Key	Arm Away	yes	no	Button	n/a
50	2	4 Button Key	Disarm	yes	no	Button	n/a
51	4	4 Button Key	Arm Stay	yes	no	Button	n/a
52	1	4 Button Key	No Response	no	no	Button	n/a
53	3	4 Button Key	Arm Away	yes	no	Button	n/a
54	2	4 Button Key	Disarm	yes	no	Button	n/a
55	4	4 Button Key	Arm Stay	yes	no	Button	n/a
56	1	4 Button Key	No Response	no	no	Button	n/a
80	n/a	Temperature	Not Used	yes	no	High Temp	n/a
81	n/a	Temperature	Not Used	yes	no	Low Temp	n/a
82	n/a	Temperature	Not Used	yes	no	High Temp	n/a
83	n/a	Temperature	Not Used	yes	no	Low Temp	n/a
84	n/a	Temperature	Not Used	yes	no	High Temp	n/a
85	n/a	Temperature	Not Used	yes	no	Low Temp	n/a
95	---	Fire	Fire No Verification	yes	no	Panic Trigger	n/a
96	---	Medical	n/a	yes	no	Panic Trigger	n/a
97	---	---	---	yes	no	Cover Tamper	n/a
99	---	Police	24-Hour Silent	yes	no	Panic Trigger	n/a

**NOTE:** Zone 1 is a hardwire zone; Zone 2 to 48 are RF zones; Zone 92 is Duress; Zone 99 is keypad panic

Zone Programming Default Tables

Zone Assignment/Alarm Report Codes for Table 2

Zone Number	Loop Number	Device Type	Response Type	Report	Chime	Supervision/ Input Type	Zone Descriptor
1	---	New	n/a	yes	no	EOLR	n/a
2	2	Door	Entry Exit 1	yes	yes	RF Supervised	Front Door
3	2	Door	Entry Exit 1	yes	yes	RF Supervised	Back Door
4	2	Door	Entry Exit 1	yes	yes	RF Supervised	Garage Door
5	1	Motion Sensor	Interior w/Delay	yes	no	RF Supervised	n/a
6	1	Smoke Detector	Fire No verification	yes	no	RF Supervised	n/a
49	3	4 Button Key	Arm Away	yes	no	Button	n/a
50	2	4 Button Key	Disarm	yes	no	Button	n/a
51	4	4 Button Key	Arm Stay	yes	no	Button	n/a
52	1	4 Button Key	No Response	no	no	Button	n/a
53	3	4 Button Key	Arm Away	yes	no	Button	n/a
54	2	4 Button Key	Disarm	yes	no	Button	n/a
55	4	4 Button Key	Arm Stay	yes	no	Button	n/a
56	1	4 Button Key	No Response	no	no	Button	n/a
80	n/a	Temperature	Not Used	yes	no	High Temp	n/a
81	n/a	Temperature	Not Used	yes	no	Low Temp	n/a
82	n/a	Temperature	Not Used	yes	no	High Temp	n/a
83	n/a	Temperature	Not Used	yes	no	Low Temp	n/a
84	n/a	Temperature	Not Used	yes	no	High Temp	n/a
85	n/a	Temperature	Not Used	yes	no	Low Temp	n/a
95	---	Fire	Fire No Verification	yes	no	Panic Trigger	n/a
96	---	Medical	24-Hour Auxiliary	yes	no	Panic Trigger	n/a
97	---	---	---	yes	no	Cover Tamper	n/a
99	---	Police	24-Hour Audible	yes	no	Panic Trigger	n/a

NOTE: Zone 1 is a hardwire zone; Zone 2 to 48 are RF zones; Zone 92 is Duress; Zone 99 is keypad panic

Zone Assignment/Alarm Report Codes for Tables 3 and 4

Zone Number	Loop Number	Device Type	Response Type	Report	Chime	Supervision/ Input Type	Zone Descriptor
1	---	New	n/a	yes	no	EOLR	n/a
2	2	Door	Entry Exit 1	yes	yes	RF Supervised	Front Door
3	2	Door	Entry Exit 1	yes	yes	RF Supervised	Back Door
4	2	Window	Perimeter	yes	no	RF Supervised	n/a
5	2	Window	Perimeter	yes	no	RF Supervised	n/a
6	2	Window	Perimeter	yes	no	RF Supervised	n/a
7	2	Window	Perimeter	yes	no	RF Supervised	n/a
8	1	Motion Sensor	Interior w/Delay	yes	no	RF Supervised	n/a
9	1	Smoke Detector	Fire No Verification	yes	no	RF Supervised	n/a
49	3	4 Button Key	Arm Away	yes	no	Button	n/a
50	2	4 Button Key	Disarm	yes	no	Button	n/a
51	4	4 Button Key	No Response	yes	no	Button	n/a
52	1	4 Button Key	No Response	no	no	Button	n/a
53	3	4 Button Key	Arm Away	yes	no	Button	n/a
54	2	4 Button Key	Disarm	yes	no	Button	n/a
55	4	4 Button Key	No Response	yes	no	Button	n/a
56	1	4 Button Key	No Response	no	no	Button	n/a
80	n/a	Temperature	Not Used	yes	no	High Temp	n/a
81	n/a	Temperature	Not Used	yes	no	Low Temp	n/a
82	n/a	Temperature	Not Used	yes	no	High Temp	n/a
83	n/a	Temperature	Not Used	yes	no	Low Temp	n/a
84	n/a	Temperature	Not Used	yes	no	High Temp	n/a
85	n/a	Temperature	Not Used	yes	no	Low Temp	n/a
95	---	Fire	Fire No Verification	yes	no	Panic Trigger	n/a
96	---	Medical	n/a	yes	no	Panic Trigger	n/a
97	---	---	---	yes	no	Cover Tamper	n/a
99	---	Police	24-Hour Silent	yes	no	Panic Trigger	n/a

NOTE: Zone 1 is a hardwire zone; Zone 2 to 48 are RF zones; Zone 92 is Duress; Zones 95, 96 and 99 are keypad panics

## **Regulatory Agency Statements**

### **Federal Communications Commission (FCC) Part 15**

The user shall not make any changes or modifications to the equipment unless authorized by the Installation Instructions or User's Manual. Unauthorized changes or modifications could void the user's authority to operate the equipment.

#### **CLASS B DIGITAL DEVICE STATEMENT**

NOTE: This equipment has been tested and found to comply with the limits for a Class B digital device, pursuant to part 15 of the FCC Rules. These limits are designed to provide reasonable protection against harmful interference in a residential installation. This equipment generates, uses and can radiate radio frequency energy and, if not installed and used in accordance with the instructions, may cause harmful interference to radio communications. However, there is no guarantee that interference will not occur in a particular installation. If this equipment does cause harmful interference to radio or television reception, which can be determined by turning the equipment off and on, the user is encouraged to try to correct the interference by one or more of the following measures:

- Reorient or relocate the receiving antenna.
- Increase the separation between the equipment and receiver.
- Connect the equipment into an outlet on a circuit different from that to which the receiver is connected.
- Consult the dealer or an experienced radio/TV technician for help.

This Class B digital apparatus complies with Canadian ICES-003.

Cet appareil numérique de la classe B est conforme à la norme NMB-003 du Canada.

#### **FCC IC Statement**

This device complies with Part 15 of FCC Rules and RSS 210 of Industry Canada. Operation is subject to the following two conditions: (1) This device may not cause harmful interference, and (2) This device must accept any interference received, including interference that may cause undesired operation.

Cet appareil est conforme à la partie 15 des règles de la FCC & de RSS 210 des Industries Canada. Son fonctionnement est soumis aux conditions suivantes: (1) Cet appareil ne doit pas causer d'interférences nuisibles. (2) Cet appareil doit accepter toute interférence reçue y compris les interférences causant une réception indésirable.

## **TELEPHONE/MODEM INTERFACE**

### **Federal Communications Commission (FCC) Part 68**

This equipment complies with Part 68 of the FCC rules. On the front cover of this equipment is a label that contains the FCC registration number and Ringer Equivalence Number (REN). You must provide this information to the telephone company when requested.

This equipment uses the following USOC jack: RJ31X

This equipment may not be used on telephone-company-provided coin service. Connection to party lines is subject to state tariffs. This equipment is hearing-aid compatible.

#### **Industry Canada**

**NOTICE:** The Industry Canada Label identifies certified equipment. This certification means that the equipment meets telecommunications network protective, operational and safety requirements as prescribed in the appropriate Terminal Equipment Technical Requirements document(s). The Department does not guarantee the equipment will operate to the user's satisfaction.

Before installing this equipment, users should ensure that it is permissible to be connected to the facilities of the local telecommunications company. The equipment must also be installed using an acceptable method of connection. The customer should be aware that compliance with the above conditions may not prevent degradation of service in some situations.

Repairs to certified equipment should be coordinated by a representative designated by the supplier. Any repairs or alterations made by the user to this equipment, or equipment malfunctions, may give the telecommunications company to request the user to disconnect the equipment.

Users should ensure for their own protection that the electrical ground connections of the power utility, telephone lines and internal metallic water pipe system, if present, are connected together. This precaution may be particularly important in rural areas.

**Caution:** Users should not attempt to make such connections themselves but should contact appropriate electric inspection authority, or electrician, as appropriate.

**AVIS:** L'étiquette d'Industrie Canada identifie le matériel homologué. Cette étiquette certifie que le matériel est conforme aux normes de protection, d'exploitation et de sécurité des réseaux de télécommunications, comme le prescrivent les documents concernant les exigences techniques relatives au matériel terminal. Le Ministère n'assure toutefois pas que le matériel fonctionnera à la satisfaction de l'utilisateur.

Avant d'installer ce matériel, l'utilisateur doit s'assurer qu'il est permis de le raccorder aux installations de l'entreprise locale de télécommunication. Le matériel doit également être installé en suivant une méthode acceptée de raccordement. L'abonné ne doit pas oublier qu'il est possible que la conformité aux conditions énoncées ci-dessus n'empêche pas la dégradation du service dans certaines situations.

Les réparations de matériel homologué doivent être coordonnées par un représentant désigné par le fournisseur. L'entreprise de télécommunications peut demander à l'utilisateur de débrancher un appareil à la suite de réparations ou de modifications effectuées par l'utilisateur ou à cause de mauvais fonctionnement.

Pour sa propre protection, l'utilisateur doit s'assurer que tous les fils de mise à la terre de la source d'énergie électrique, de lignes téléphoniques et des canalisations d'eau métalliques, s'il y en a, sont raccordés ensemble. Cette précaution est particulièrement importante dans les régions rurales.

**Avertissement :** L'utilisateur ne doit pas tenter de faire ces raccordements lui-même; il doit avoir recours à un service d'inspection des installations électriques, ou à un électricien, selon le cas.

#### **Ringer Equivalence Number Notice:**

The **Ringer Equivalence Number (REN)** assigned to each terminal device provides an indication of the maximum number of terminals allowed to be connected to a telephone interface. The termination on an interface may consist of any combination of devices subject only to the requirement that the sum of the Ringer Equivalence Numbers of all the devices does not exceed 5.

**AVIS : L'indice d'équivalence de la sonnerie (IES)** assigné à chaque dispositif terminal indique le nombre maximal de terminaux qui peuvent être raccordés à une interface. La terminaison d'une interface téléphonique peut consister en une combinaison de quelques dispositifs, à la seule condition que la somme d'indices d'équivalence de la sonnerie de tous les dispositifs n'exécède pas 5.

### **RF Exposure**



**WARNING:** The LYNX Touch must be installed to provide a separation distance of at least 7.8 in (20 cm) from all persons and not co-located or operated in conjunction with any other transmitter except in accordance with FCC multi-transmitter product procedures.

**WARNING**  
**THE LIMITATIONS OF THIS ALARM SYSTEM**

While this System is an advanced design security system, it does not offer guaranteed protection against burglary, fire or other emergency. Any alarm system, whether commercial or residential, is subject to compromise or failure to warn for a variety of reasons. For example:

- Intruders may gain access through unprotected openings or have the technical sophistication to bypass an alarm sensor or disconnect an alarm warning device.
- Intrusion detectors (e.g., passive infrared detectors), smoke detectors, and many other sensing devices will not work without power. Battery-operated devices will not work without batteries, with dead batteries, or if the batteries are not put in properly. Devices powered solely by AC will not work if their AC power supply is cut off for any reason, however briefly.
- Signals sent by wireless transmitters may be blocked or reflected by metal before they reach the alarm receiver. Even if the signal path has been recently checked during a weekly test, blockage can occur if a metal object is moved into the path.
- A user may not be able to reach a panic or emergency button quickly enough.
- While smoke detectors have played a key role in reducing residential fire deaths in the United States, they may not activate or provide early warning for a variety of reasons in as many as 35% of all fires, according to data published by the Federal Emergency Management Agency. Some of the reasons smoke detectors used in conjunction with this System may not work are as follows. Smoke detectors may have been improperly installed and positioned. Smoke detectors may not sense fires that start where smoke cannot reach the detectors, such as in chimneys, in walls, or roofs, or on the other side of closed doors. Smoke detectors also may not sense a fire on another level of a residence or building. A second floor detector, for example, may not sense a first floor or basement fire. Finally, smoke detectors have sensing limitations. No smoke detector can sense every kind of fire every time. In general, detectors may not always warn about fires caused by carelessness and safety hazards like smoking in bed, violent explosions, escaping gas, improper storage of flammable materials, overloaded electrical circuits, children playing with matches, or arson. Depending on the nature of the fire and/or location of the smoke detectors, the detector, even if it operates as anticipated, may not provide sufficient warning to allow all occupants to escape in time to prevent injury or death.
- Passive Infrared Motion Detectors can only detect intrusion within the designed ranges as diagrammed in their installation manual. Passive Infrared Detectors do not provide volumetric area protection. They do create multiple beams of protection, and intrusion can only be detected in unobstructed areas covered by those beams. They cannot detect motion or intrusion that takes place behind walls, ceilings, floors, closed doors, glass partitions, glass doors, or windows. Mechanical tampering, masking, painting or spraying of any material on the mirrors, windows or any part of the optical system can reduce their detection ability. Passive Infrared Detectors sense changes in temperature; however, as the ambient temperature of the protected area approaches the temperature range of 90° to 105°F (32° to 40°C), the detection performance can decrease.
- Alarm warning devices such as sirens, bells or horns may not alert people or wake up sleepers if they are located on the other side of closed or partly open doors. If warning devices are located on a different level of the residence from the bedrooms, then they are less likely to waken or alert people inside the bedrooms. Even persons who are awake may not hear the warning if the alarm is muffled by noise from a stereo, radio, air conditioner or other appliance, or by passing traffic. Finally, alarm warning devices, however loud, may not warn hearing-impaired people.
- Telephone lines needed to transmit alarm signals from a premises to a central monitoring station may be out of service or temporarily out of service. Telephone lines are also subject to compromise by sophisticated intruders.
- Even if the system responds to the emergency as intended, however, occupants may have insufficient time to protect themselves from the emergency situation. In the case of a monitored alarm system, authorities may not respond appropriately.
- This equipment, like other electrical devices, is subject to component failure. Even though this equipment is designed to last as long as 10 years, the electronic components could fail at any time.

The most common cause of an alarm system not functioning when an intrusion or fire occurs is inadequate maintenance. This alarm system should be tested weekly to make sure all sensors and transmitters are working properly. The security keypad (and remote keypad) should be tested as well.

Wireless transmitters (used in some systems) are designed to provide long battery life under normal operating conditions. Longevity of batteries may be as much as 4 to 7 years, depending on the environment, usage, and the specific wireless device being used. External factors such as humidity, high or low temperatures, as well as large swings in temperature, may all reduce the actual battery life in a given installation. This wireless system, however, can identify a true low battery situation, thus allowing time to arrange a change of battery to maintain protection for that given point within the system.

Installing an alarm system may make the owner eligible for a lower insurance rate, but an alarm system is not a substitute for insurance. Homeowners, property owners and renters should continue to act prudently in protecting themselves and continue to insure their lives and property.

We continue to develop new and improved protection devices. Users of alarm systems owe it to themselves and their loved ones to learn about these developments.

**UL Notices**

1. For UL Residential Burglar Alarm installations with line security, total exit delay time must not exceed 60 seconds. For UL Burglar Alarm installations without line security, total exit delay time must not exceed 120 seconds.
2. Periodic testing must be at least every 24 hours.
3. Remote downloading without an alarm company technician on-site (unattended downloading) is not permissible for UL installations.
4. Auto-disarming is not a UL Listed feature.
5. As SIA limits for delay of alarm reporting and sounding can exceed UL limits for commercial and residential applications, the following UL requirements per UL681 are provided:  
The maximum time that a control unit shall be programmed to delay the transmission of a signal to a remote monitoring location, or to delay the energizing of a local alarm sounding device to permit the alarm system user to enter and disarm the system, or to arm the system and exit shall not exceed:
  - a) 60 seconds for a system with standard line security or encrypted line security,
  - b) 120 seconds for a system without standard line security or encrypted line security, or
  - c) 120 seconds for a system that does not transmit an alarm signal to a remote monitoring location.

**SIA Quick Reference Guide**

Programming Section	Feature	Range	Shipping Default	SIA Requirement
<b>Installation and Setup Guide or Programming Guide</b>				
<b>Reporter/ Report Selection</b>	Exit Error	Enabled or Disabled	Enabled	Enabled
	Recent Closing	Enabled or Disabled	Enabled	Enabled
	Alarm Cancel	Enabled or Disabled	Enabled	Enabled
<b>Reporter/Options</b>	Call Wait Cancel	Enabled or Disabled	Field is blank (a PBX prefix is entered to enable)	Enabled if User has call waiting
	Swinger Shutdown	1 to 6 Reports	2 Reports	2 Reports
	Abort Window	15, 30 and 45 seconds	30 Seconds	30 Seconds*
<b>System Settings</b>	Entry Delay # 1	30, 45, 60 and 90 seconds and 2, 3 or 4 minutes	30 Seconds	30 Seconds minimum
	Entry Delay # 2	30, 45, 60 and 90 seconds and 2, 3 or 4 minutes	30 Seconds	30 Seconds minimum
	Exit Delay	45, 60, 90 seconds and 2 minutes	60 Seconds	45 seconds minimum
	Restart Exit Time	Enabled or Disabled	Yes (Enabled)	Enabled
	Exit Warning	Not selectable	Always enabled	Enabled
	Auto Stay Arming	Enabled or Disabled	Yes (Enabled)	Enabled
	Cross Zone Delay	30 seconds and 2 minutes (in 30 second increments), 3 minutes and 4 minutes	None (Disabled)	Enabled and two zones programmed
<b>Zones</b>	Fire Alarms	Zone Type "Fire with Verification" must be selected for Fire Zone 95	Disabled	Disabled
<b>User Guide</b>				
<b>User Functions/ User Access</b>	Duress	Duress Code is Programmed by Master User as User 16	Disabled	Disabled
<b>System Functions/ Testing the System**</b>	System Test	System tests provided as a User Function	n/a	n/a
	Communications	While the system is in Test mode, no alarm reports are sent to the central station	Disabled	Disabled

\* Combined Entry Delay and Abort Window should not exceed 1 minute.

\*\* Refer to the User Guide for procedures on Testing the System.

**Note:** Using the Call Waiting Cancel feature on a non-Call Waiting line will prevent successful communication to the central station.

## **Specifications**

### **LYNX Touch Series Security Controls**

#### **Physical:**

Dimensions: 8.5" W x 6" H x 1.875" D

#### **Electrical:**

Voltage Input: 9 Vdc from plug-in 2.7A power supply

Rechargeable Backup Battery: Nickel-metal hydride battery pack rated at 7.2 Vdc

#### **Communication:**

Formats Supported: ADEMCO Contact ID® Reporting, 10 characters/sec., DTMF (TouchTone)  
Data Tones, 1400/2300Hz Handshake, 1400Hz KISSOFF.

SIA/DCS Format, 2225Hz Handshake, Data Tones, 2025/2235Hz, baud

Line Seize: Double Pole

Ringer Equivalence: 0.5B

ACTA Registration No.: US: AC3AL05BL5000

**Hardwire Zone:** 2K ohms, End of Line Resistor (EOLR), 200 ohms max wire resistance, dry contacts only

**Trigger Output:** 1k ohms to ground when closed (output low) 3ma



**Contacting Technical Support**

**PLEASE, before you call Technical Support, be sure you:**

- READ THE INSTRUCTIONS!
- Check all wiring connections.
- Determine that the power supply and/or backup battery are supplying proper voltages.
- Verify your programming information where applicable.
- Note the proper model number of this product, and the version level (if known) along with any documentation that came with the product.
- Note your Honeywell customer number and/or company name.

Having this information handy will make it easier for us to serve you quickly and effectively.

<i>Technical Support:</i> ..... 1-800-645-7492 (8 a.m.-10 p.m. E.S.T.)
<i>MyWebTech:</i> ..... <a href="http://www.honeywell.com/security/hsc/resources/MyWebTech">http://www.honeywell.com/security/hsc/resources/MyWebTech</a>

## **Glossary**

AES – Advanced Encryption Standard

APL – Advanced Protection Logic

DHCP – Dynamic Host Configuration Protocol, which provides a mechanism for allocating IP addresses dynamically so that addresses can be reused when hosts no longer need them.

DNS – Domain Name System, which is a distributed hierarchical naming system used to resolve domain names (e.g., www.yahoo.com) into numerical IP addresses (e.g., 204.17.25.1).

Gateway IP Address – A gateway (sometimes called a router) is a computer and/or software used to connect two or more networks (including incompatible networks) and translates information from one network to the other. The Gateway IP address is the IP address for the gateway.

GPRS – General Packet Radio Service

GSM – Global System for Mobile communications, which is an international standard for digital mobile phone systems used for cellular communication.

IMEI – International Mobile Equipment Identity number

IP – Internet Protocol

IP Address – A unique number consisting of four parts separated by periods, sometimes called a "dotted quad.," for example: 204.17.29.11, assigned to every computer/workstation connected to the Internet. IP numbers can be "static" (assigned and unchanging) or "dynamic," assigned via DHCP at each and every startup.

ISP – Internet Service Provider

MAC ID – Media Access Code; located on the module label.

NIC – Network Interface Card

RSSI – Received Signal Strength Indication

SCID – SIM Card ID

Subnet Mask – A Subnet is a portion of a network that shares a network address with other portions of the network, and is distinguished by a subnet number. The Subnet Mask is a 32-bit address mask used in IP to indicate the bits of an IP address that are being used for the subnet address.

WPS – WiFi Protected Setup

**– Notes –**

**– Notes –**

**– Index –**

24-Hour Silent .....	52	Exiting Program Mode .....	19
300-03864-1.....	5	Factory Defaults .....	49
300-03866.....	5	Features .....	5
300-04063.....	5, 9	Flexible Callback .....	50
300-04065.....	5, 9	Follow Me Reminder Feature .....	55
300-04705.....	5, 9	Follow Me System Announcement .....	54
5800 Series Transmitter Loop Numbers .....	15	Force Bypass.....	40
5800 Series Transmitters .....	5, 13	General Programming Information .....	18
5802MN.....	13	Go/No Go Test.....	14
5802MN2.....	13	GSM Information.....	43
5804.....	13	GSMVLP5.....	10, 25
5804BD.....	13	Home Screen .....	16
5804BDV .....	13	House Identification .....	13
5804E .....	13	ILP5.....	10, 11, 12
5805-6.....	13	Installer Code .....	52
5806.....	15	Installer Menu .....	17
5816.....	13	Installing Wireless Zones.....	14, 15
5817.....	13	Installing/Configuring Communication & Home Automation Modules .....	11, 12
AC Power .....	9	Key/Touchscreen Operation .....	52
AC Power Loss.....	9	Keys.....	13
ADEMCO Contact ID .....	5, 72	L5000DM .....	6
Armed System Test .....	59	L5100-WiFi Module.....	12
Audio Alarm Verification (Two-Way Voice Feature).....	57	Lack of Usage Notify .....	40
Auto Stay Arming.....	40	Liquid Crystal Display (LCD) Touch-Screen .....	16
Babysitter Code .....	53	Loading Factory Defaults.....	18
Backup Battery.....	9, 72	LYNX Touch Programming Default Tables .....	61
Button Transmitters.....	13	LYNX Touch Sia Programming Default Tables....	64
Case Tamper .....	5	LYNXRCHKIT-SC.....	5
Change Installer Code.....	22	LYNXRCHKIT-SHA.....	5
Communication Modules.....	10	Master Code.....	52
Communications ID Numbers .....	44	Master Security Code .....	53
Communications Status .....	43	User Security Code.....	52
Installing/Configuring Communication & Home Automation Modules .....	10	Memory of Alarm.....	52
Contact ID Event Log Codes .....	58	Menu Screens .....	16, 17
Contact ID Reporting .....	72	Mounting Base.....	6
Contacting Technical Support.....	73	Navigating Menus .....	16
Cross Zone 1/Cross Zone 2.....	40	Navigation Keys .....	16
Cross Zone Delay .....	40, 41, 42	Operator Commands .....	57
Data Encryption .....	50	Panic Key/Icons .....	52
Desktop Mounting .....	6	Plug-in Power Supply.....	9
Diagnostics.....	44	Power-up in Previous .....	40
Diagnostics.....	43	Program Date and Time.....	25
Dialer Delay.....	59	Program Keys .....	31
Dialer Test .....	59	Program the Communications Module.....	26
Dip Switches .....	13	Program the Z-Wave Module .....	28
Disarm.....	16	Program Zones.....	29
Display Alarm Cancel.....	40	Quick Arm.....	40
Display Exit Time.....	40	Quick Exit.....	40
Duress Code .....	53	Range .....	13
Enroll The WiFi Module.....	47	Reboot .....	60
Enter Installer Programming Mode .....	18	Rebooting the System.....	60
Enter/Change The Master Code .....	52	Register by Phone.....	45
Entry Delay1/Entry Delay 2 .....	40	Register Device with Pin.....	46
Entry/Exit Burglary .....	20	Register through Alarmnet Direct Website .....	45
Ethernet Information .....	43	Register through LYNX Touch Diagnostics .....	45
Exit Delay .....	5, 17, 20, 40, 59, 70	Registering The LYNX Touch.....	44
Exit Door .....	40	Regulatory Agency Statements.....	68
Exit Warning .....	40	Remote Phone Control.....	55
		Remote Programming .....	50

Remote Programming/Control .....	50	Technical Support.....	73
Reporter.....	33, 34	Test Communications.....	44
Reset Master User Code.....	53	Test Ethernet.....	44
Resident Monitor Zone Types.....	5	Test Modes.....	59
RF Sniffer Test Mode.....	14	Testing the System.....	59, 60
Secondary User Codes.....	53	Touch-Screen Display.....	16
Security Code.....	40	Transmitter Battery Life.....	13
Security Code Handshake.....	50	Transmitter Input Type.....	13
Security Codes.....	52	Transmitter Loop Numbers.....	15
Setup Communication.....	44	Transmitter Supervision.....	13
SIA (DC-03).....	5	Unsupervised Button.....	13
SIA Event Log Codes.....	58	Unsupervised RF.....	13
Silent Burglary.....	21	Update Server.....	47
Site-Initiated Remote Programming.....	50	User Menu.....	17
Sniffer Mode.....	59	Wall Mounting.....	6
Sounder.....	39	Wireless Buttons.....	13
Specifications.....	72	Wireless Keypads.....	5, 13, 14
Station-Initiated Remote Programming.....	50	Wireless Zones.....	13
Super High Capacity Battery.....	10	Wiring Connections.....	6
Supervised RF.....	13	World Wide Web Address.....	73
System Features.....	5	Zone Discovery.....	60
System Operation.....	52, 53	Zone Programming Default Tables.....	66, 67
System Settings.....	40	Zone Response Type Definitions.....	20

THIS EQUIPMENT SHOULD BE INSTALLED IN ACCORDANCE WITH THE NATIONAL FIRE PROTECTION ASSOCIATION STANDARDS, ANS/NFPA 70 NATIONAL ELECTRIC CODE AND NEPA 72 NATIONAL FIRE ALARM CODE, CHAPTER 2 (NATIONAL FIRE PROTECTION ASSOC., BATTERY MARCH PARK, QUINCY, MA 02169), PRINTED INFORMATION DESCRIBING PROPER INSTALLATION, EVACUATION PLANNING AND REPAIR SERVICE IS TO BE PROVIDED WITH THIS EQUIPMENT.

LYNX TOUCH SERIES ALSO COMPLES WITH THE FOLLOWING:  
 CANADIAN STANDARDS ASSOCIATION (CSA) C22.1,  
 CANADIAN ELECTRICAL CODE, PART 1, SAFETY STANDARD  
 FOR ELECTRICAL INSTALLATIONS AND CAN/ULC-S540  
 INSTALLATION OF RESIDENTIAL FIRE WARNING SYSTEMS.

THIS DEVICE COMPLIES WITH PART 15 OF FCC RULES. OPERATION IS SUBJECT TO THE FOLLOWING TWO CONDITIONS: (1) THIS DEVICE MAY NOT CAUSE HARMFUL INTERFERENCE, AND (2) THIS DEVICE MUST ACCEPT ANY INTERFERENCE RECEIVED, INCLUDING INTERFERENCE THAT MAY CAUSE UNDESIRABLE OPERATION.

**WARNING**  
 TO PREVENT RISK OF SHOCK, DISCONNECT TELEPHONE LINE AT TELECOM JACK BEFORE SERVICING THIS UNIT

UL INSTALLATIONS THE MINIMUM WIRE SIZE USED FOR TELEPHONE INSTALLATIONS MUST BE #26 GAGE

NOTE: THE HARDWIRE ZONE CANNOT BE USED AS A FIRE ZONE.

**\* IMPORTANT \***  
 Be sure to observe polarity when connecting the power supply to the terminal strip.

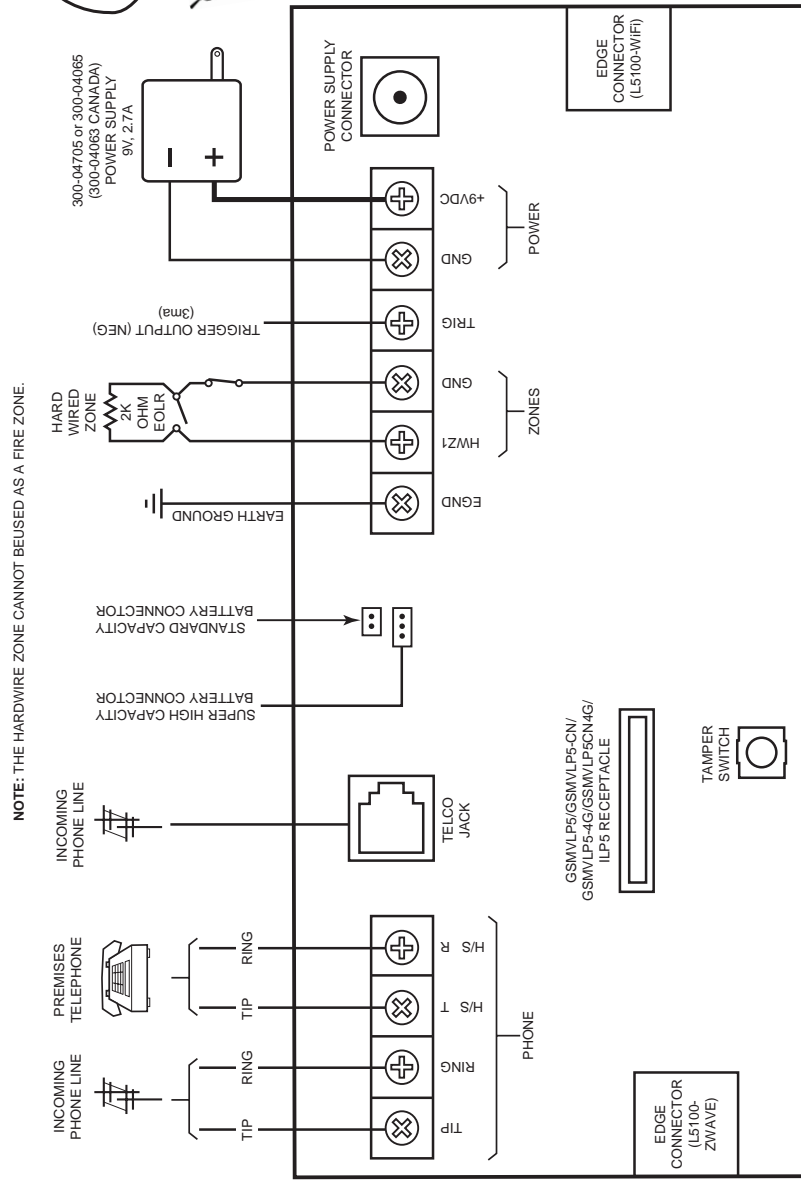

COMPLIES WITH FCC RULES, PART 68 FCC REGISTRATION No. AC3AL05BL5000 RINGER EQUIVALENCE: 0.5B

THE LYNX TOUCH CONTROLS ARE COMPATIBLE WITH THE FOLLOWING INTEGRAL RECHARGEABLE BATTERY PACKS:  
 P/N 300-03864-1/LYNXRCHKIT-SC  
 P/N 300-03866/LYNXRCHKIT-SHA  
**REPLACE EVERY FOUR YEARS**

**WARNING**  
 THIS UNIT MAY BE PROGRAMMED TO INCLUDE AN ALARM VERIFICATION FEATURE THAT WILL RESULT IN A DELAY OF THE SYSTEM ALARM SIGNAL FROM THE INDICATED FIRE CIRCUITS. THE TOTAL DELAY (CONTROL UNIT PLUS SMOKE DETECTORS) SHALL NOT EXCEED 60 SECONDS. NO OTHER INITIATING DEVICES SHALL BE CONNECTED TO THESE CIRCUITS UNLESS APPROVED BY THE LOCAL AUTHORITY HAVING JURISDICTION.

CIRCUIT (ZONE)	CONTROL UNIT DELAY-SEC	SMOKE DETECTOR MODEL	SMOKE DETECTOR DELAY-SEC
02-48 ZT116	30 seconds	5808W3	10 seconds

WEEKLY TESTING IS REQUIRED TO ENSURE PROPER OPERATION OF THIS SYSTEM

LYNX TOUCH SERIES SUMMARY OF CONNECTIONS

**Notes:** Connection of the fire alarm signal to a fire alarm headquarters or a central station shall be permitted with the approval of the local authority having jurisdiction. The burglar alarm signal shall not be connected to a police emergency number. The System must be checked by a qualified technician once every three years

## **WARRANTY INFORMATION**

For the latest warranty information, please visit:

[www.honeywell.com/security/hsc/resources/wa](http://www.honeywell.com/security/hsc/resources/wa)

# **Honeywell**

**2 Corporate Center Drive, Suite 100**

**P.O. Box 9040, Melville, NY 11747**

Copyright © 2012 Honeywell International Inc.

[www.honeywell.com/security](http://www.honeywell.com/security)



800-10614 1/12 Rev. A